



P4S533-VM

User Manual

Motherboard

P4S533-VM

E1058

June 2002

Copyright © 2002 ASUSTeK COMPUTER INC. All Rights Reserved.

No part of this manual, including the products and software described in it, may be reproduced, transmitted, transcribed, stored in a retrieval system, or translated into any language in any form or by any means, except documentation kept by the purchaser for backup purposes, without the express written permission of ASUSTeK COMPUTER INC. ("ASUS").

Product warranty or service will not be extended if: (1) the product is repaired, modified or altered, unless such repair, modification or alteration is authorized in writing by ASUS; or (2) the serial number of the product is defaced or missing.

Products and corporate names appearing in this manual may or may not be registered trademarks or copyrights of their respective companies, and are used only for identification or explanation and to the owners' benefit, without intent to infringe.

The product name and revision number are both printed on the product itself. Manual revisions are released for each product design represented by the digit before and after the period of the manual revision number. Manual updates are represented by the third digit in the manual revision number.

For previous or updated manuals, BIOS, drivers, or product release information, contact ASUS at: <http://www.asus.com> or through any of the means indicated on the following page.

ASUS PROVIDES THIS MANUAL "AS IS" WITHOUT WARRANTY OF ANY KIND, EITHER EXPRESS OR IMPLIED, INCLUDING BUT NOT LIMITED TO THE IMPLIED WARRANTIES OR CONDITIONS OF MERCHANTABILITY OR FITNESS FOR A PARTICULAR PURPOSE. IN NO EVENT SHALL ASUS, ITS DIRECTORS, OFFICERS, EMPLOYEES OR AGENTS BE LIABLE FOR ANY INDIRECT, SPECIAL, INCIDENTAL, OR CONSEQUENTIAL DAMAGES (INCLUDING DAMAGES FOR LOSS OF PROFITS, LOSS OF BUSINESS, LOSS OF USE OR DATA, INTERRUPTION OF BUSINESS AND THE LIKE), EVEN IF ASUS HAS BEEN ADVISED OF THE POSSIBILITY OF SUCH DAMAGES ARISING FROM ANY DEFECT OR ERROR IN THIS MANUAL OR PRODUCT.

SPECIFICATIONS AND INFORMATION CONTAINED IN THIS MANUAL ARE FURNISHED FOR INFORMATIONAL USE ONLY, AND ARE SUBJECT TO CHANGE AT ANY TIME WITHOUT NOTICE, AND SHOULD NOT BE CONSTRUED AS A COMMITMENT BY ASUS. ASUS ASSUMES NO RESPONSIBILITY OR LIABILITY FOR ANY ERRORS OR INACCURACIES THAT MAY APPEAR IN THIS MANUAL, INCLUDING THE PRODUCTS AND SOFTWARE DESCRIBED IN IT.

About this guide

This user manual contains complete information for installing the ASUS P4S533-VM motherboard.

How this guide is organized

- **Chapter 1: Product introduction.** A summary of product features and special attributes of new technologies.
- **Chapter 2: Hardware information.** A list of hardware setup procedures and descriptions of all jumpers and connectors on the motherboard.
- **Chapter 3: Powering up.** Describes the power up sequence with information on BIOS beep codes.
- **Chapter 4: BIOS setup.** How to change system settings using onboard BIOS firmware. Detailed descriptions of the BIOS parameters are supplied.
- **Chapter 5: Software support.** A summary of contents on the motherboard support CD ROM.
- **Appendix and Glossary.** Optional components and technical definitions.
- **Index**

Conventions used in this guide

To make sure that you perform set-up tasks properly, take note of the following symbols used throughout this manual.



WARNING! Information to prevent injury to yourself.



CAUTION! Information to prevent damage to the components.



IMPORTANT! Information that you **MUST** follow to complete a task.



NOTE! Tips and helpful information.

Contents

About this guide	iii
How this guide is organized	iii
Conventions used in this guide	iii
Safety information	vi
FCC/CDC statements	vii
ASUS contact information	viii
Chapter 1: Product introduction	1
Welcome!	1
1.1 Package contents	1
1.2 Core Specifications	2
1.3 Value-added Solutions	3
1.4 Motherboard Components	4
1.4.1 Component Locations	5
Chapter 2: Hardware information	1
2.1 Motherboard installation	7
2.1 Motherboard installation	7
2.1.1 Placement direction	7
2.1.2 Screw holes	7
2.2 Motherboard layout	8
2.2.1 Layout contents	9
2.3 Before you proceed	10
2.4 Central Processing Unit (CPU)	11
2.4.1 Overview	11
2.4.2 Installing the CPU	12
2.4.3 Installing the heatsink and fan	14
2.4.4 Connecting the CPU fan cable	16
2.5 System memory	17
2.5.1 Overview	17
2.5.2 Memory configurations	18
2.5.3 Installing a DIMM	19
2.5.4 Removing a DIMM	20
2.6 Expansion slots	21
2.6.1 Installing an expansion card	21
2.6.2 Configuring an expansion card	22
2.6.3 PCI slots	23
2.6.4 AGP slot	23
2.7 Jumpers	24

Contents

2.8	Connectors	29
Chapter 3: Powering up		41
3.1	Starting up for the first time	41
3.3	Powering off the computer	42
Chapter 4: BIOS setup		43
4.1	Managing and updating your BIOS	43
4.1.1	Using the computer system for the first time	43
4.1.2	Updating BIOS procedures	45
4.2	BIOS Setup program	47
4.2.1	BIOS menu bar	48
4.2.2	Legend bar	48
4.3	Main menu	50
4.3.1	Primary & Secondary Master/Slave	51
4.3.2	Keyboard Features	55
4.4	Advanced Menu	57
4.4.1	Chip Configuration	59
4.4.2	I/O Device Configuration	62
4.4.3	PCI Configuration	64
4.5	Power Menu	67
4.5.1	Power Up Control	69
4.5.2	Hardware Monitor	71
4.6	Boot Menu	72
4.7	Exit Menu	74
Chapter 5: Software support		77
5.1	Install an operating system	77
5.2	Support CD information	77
5.3	P4S533-VM Motherboard Support CD	78
5.4	ASUS PC Probe	80
5.5	ASUS Live Update	85
5.6	3Deep Color Tuner	86
5.7	ITE GSM Editor	88
Glossary		93
Index		97

Safety information

Electrical safety

- To prevent electrical shock hazard, disconnect the power cable from the electrical outlet before relocating the system.
- When adding or removing devices to or from the system, ensure that the power cables for the devices are unplugged before the signal cables are connected. Disconnect all power cables from the existing system before you add a device.
- Before connecting or removing signal cables from the motherboard, ensure that all power cables are unplugged.
- Seek professional assistance before using an adapter or extension cord. These devices could interrupt the grounding circuit.
- Make sure that your power supply is set to the voltage available in your area.
- If the power supply is broken, contact a qualified service technician or your retailer.

Operational safety

- Before installing the motherboard and adding new devices, carefully read all the manuals that came with the package.
- Before use ensure all cables are correctly connected and the power cables are not damaged. If you detect any damage, contact the dealer immediately.
- To avoid short circuits, keep paper clips, screws, and staples away from connectors, slots, sockets and circuitry.
- Avoid dust, humidity, and temperature extremes. Do not place the product in any area where it may become wet.
- Mount the motherboard inside a standard PC enclosure.
- If you encounter technical problems with the product, contact a qualified service technician or the dealer.

FCC/CDC statements

Federal Communications Commission Statement

This device complies with FCC Rules Part 15. Operation is subject to the following two conditions:

- This device may not cause harmful interference, and
- This device must accept any interference received including interference that may cause undesired operation.

This equipment has been tested and found to comply with the limits for a Class B digital device, pursuant to Part 15 of the FCC Rules. These limits are designed to provide reasonable protection against harmful interference in a residential installation. This equipment generates, uses and can radiate radio frequency energy and, if not installed and used in accordance with manufacturer's instructions, may cause harmful interference to radio communications. However, there is no guarantee that interference will not occur in a particular installation. If this equipment does cause harmful interference to radio or television reception, which can be determined by turning the equipment off and on, the user is encouraged to try to correct the interference by one or more of the following measures:

- Reorient or relocate the receiving antenna.
- Increase the separation between the equipment and receiver.
- Connect the equipment to an outlet on a circuit different from that to which the receiver is connected.
- Consult the dealer or an experienced radio/TV technician for help.



The use of shielded cables for connection of the monitor to the graphics card is required to assure compliance with FCC regulations. Changes or modifications to this unit not expressly approved by the party responsible for compliance could void the user's authority to operate this equipment.

Canadian Department of Communications Statement

This digital apparatus does not exceed the Class B limits for radio noise emissions from digital apparatus set out in the Radio Interference Regulations of the Canadian Department of Communications.

This class B digital apparatus complies with Canadian ICES-003.

ASUS contact information

ASUSTeK COMPUTER INC. (Asia-Pacific)

Address: 150 Li-Te Road, Peitou, Taipei, Taiwan 112
General Tel: +886-2-2894-3447
General Fax: +886-2-2894-3449
General Email: info@asus.com.tw

Technical Support:

MB/Others (Tel): +886-2-2890-7121 (English)
Notebook (Tel): +886-2-2890-7122 (English)
Desktop/Server (Tel): +886-2-2890-7123 (English)
Support Fax: +886-2-2890-7698
Support Email: tsd@asus.com.tw
Web Site: www.asus.com.tw
Newsgroup: cscnews.asus.com.tw

ASUS COMPUTER INTERNATIONAL (America)

Address: 6737 Mowry Avenue, Mowry Business Center,
Building 2, Newark, CA 94560, USA
General Fax: +1-510-608-4555
General Email: tmd1@asus.com

Technical Support:

Support Fax: +1-510-608-4555
General Support: +1-502-995-0883
Notebook Support: +1-877-918-ASUS (2787)
Web Site: www.asus.com
Support Email: tsd@asus.com

ASUS COMPUTER GmbH (Europe)

Address: Harkortstr. 25, 40880 Ratingen, BRD, Germany
General Fax: +49-2102-442066
General Email: sales@asuscom.de (for marketing requests only)

Technical Support:

Support Hotline: MB/Others: +49-2102-9599-0
Notebook (Tel): +49-2102-9599-10
Support Fax: +49-2102-9599-11
Support (Email): www.asuscom.de/de/support (for online support)
Web Site: www.asuscom.de

Chapter 1

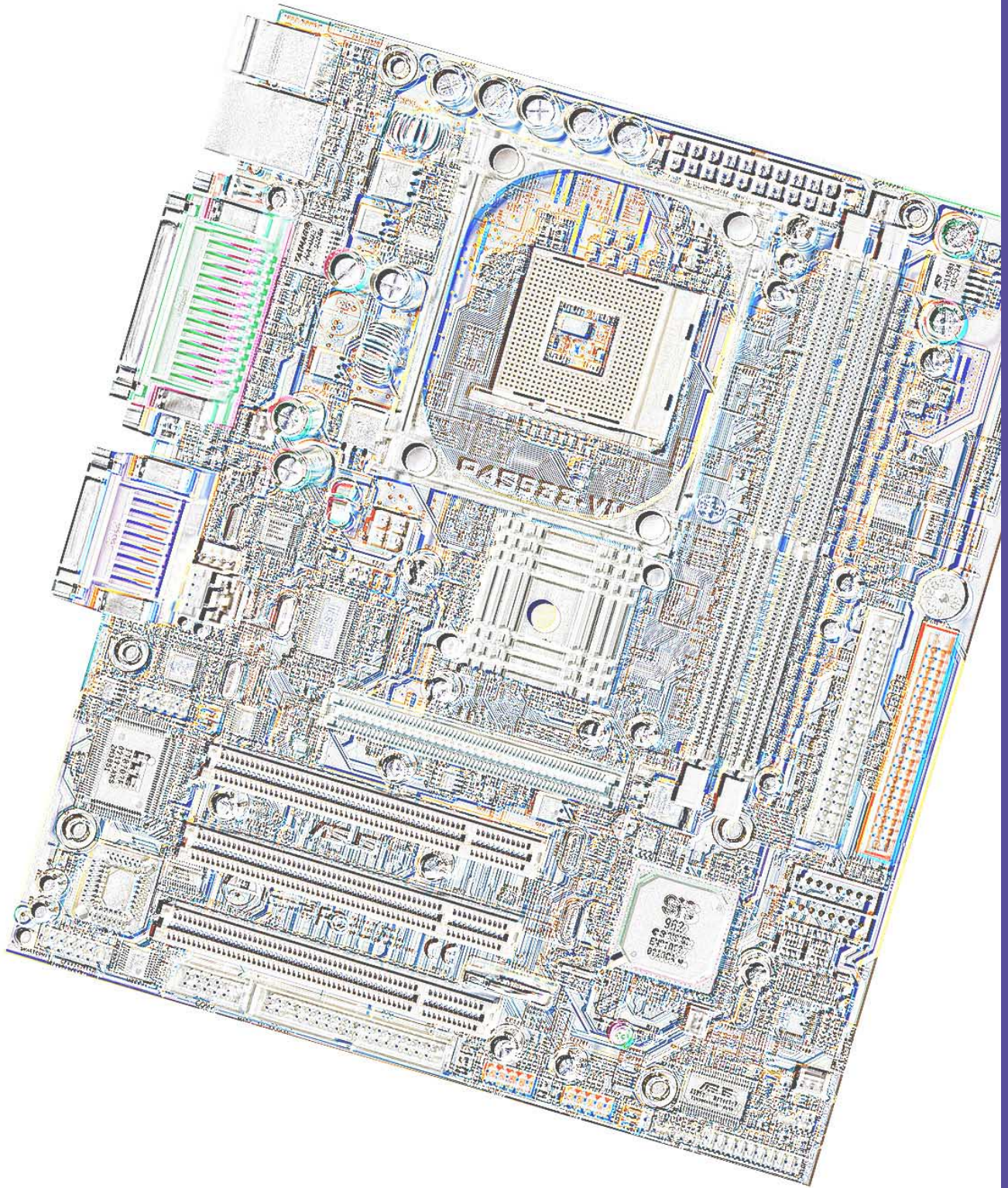

Product introduction

Welcome!

Thank you for buying the ASUS® P4S533-VM motherboard!

The ASUS P4S533-VM motherboard delivers a host of new features to ensure long-lasting, superlative performance. The ASUS® P4S533-VM motherboard is the prime choice for home PCs and workstations.

The P4S533-VM incorporates the Intel® Pentium® 4 Processor coupled with the SiS 651 chipset to set a new benchmark for an effective desktop platform solution.

- ~ CPU Thermal Protection
- ~ Up to 2GB of system memory of PC 2700 / 2100 / 1600 DDR
- ~ High-resolution graphics via an AGP 4X slot
- ~ Digital Audio Interface for 3D sound
- ~ Realtek™ LAN Controller onboard
- ~ Two USB ports plus two headers for four more

Before installing the motherboard, check the items in your package:

1.1 Package contents

Check your P4S533-VM package for the following items.

- ✓ ASUS P4S533-VM motherboard (micro-ATX 24.4 cm x 20.9 cm)
- ✓ ASUS P4S533-VM support CD
- ✓ ASUS 4-port USB 2.0 module
- ✓ 40 pin conductor ribbon cable for UltraDMA/33/66/100/133 IDE drives
- ✓ 9 pin COM2 cable
- ✓ Ribbon cable for a 3.5-inch floppy drive
- ✓ Bag of extra jumper caps
- ✓ User Guide



If any of the above items is damaged or missing, contact your retailer.

1.2 Core Specifications

The P4S533-VM motherboard is designed and assembled according to the highest standards. This ASUS motherboard represents the latest advances to supply users the finest componentry available today...

Latest 533MHz P4 Processor Technology: Intel Pentium 4 Socket 478 Northwood Processor. The Pentium 4 processor utilizes the advanced 0.18 micron processor core in FC-PGA2 package for a 2.0GHz frequency, while the Northwood processor uses the 0.13 micron processor core with 512KB L2 cache for up to a speedy 2.53+ GHz frequency and a 533 MHz FSB. The P4 offers optimized performance for audio, video, and Internet applications.

North Bridge Chipset: the **SiS® 651** supports AGP 4X/2X mode, 133/100MHz Front Side Bus, and the fastest 333 MHz memory bus.

South Bridge Chipset: the **SiS® 962L** integrated peripheral controller supports UltraDMA133/100/66/33 for burst mode data transfer rates up to 133MB/sec, and USB controller with three root hubs for six USB ports.

PC 2700 / 2100 / 1600 DDR Support: Equipped with two Double Data Rate Dual Inline Memory Module (DDR DIMM) sockets to support up to 2GB of DDR DRAM, the newest memory standard with the highest bandwidth and lowest latency currently available. This new memory technology increases performance by executing two actions per clock cycle, resulting in data transfer rates of up to 2.7 GB/s for 166MHz DDR SDRAM and 2.1GB/s for 133MHz DDR SDRAM.

UltraDMA133 Support: Comes with an onboard PCI Bus Master IDE controller with two connectors that support four IDE devices on two channels. Supports UltraDMA133/100/66/33, PIO Modes 3 & 4, Bus Master IDE DMA Mode 2, and Enhanced IDE devices, such as DVD-ROM, CD-ROM, CD-R/RW, LS-120, and Tape Backup drives.

Multi-I/O Chipset: The ITE 8707F chip offers complete support for a variety of I/O functions. Provides two high-speed UART compatible serial ports and one parallel port with EPP and ECP capabilities. UART2 can switch from COM2 to the Infrared Module for wireless connections. The Super I/O controller supports a floppy disk drive.

Smart BIOS: 2Mb firmware enables boot block write protection, and HD/SCSI/MO/ZIP/CD/Floppy boot selection.

Expansion: One AGP 4X, four USB ports, one COM port, one COM header, three PCI slots, SPDIF digital audio, front audio panel, headers, smart card header, CIR infrared, serial IRQ header.

Connections: Parallel, PS/2 mouse, PS/2 keyboard, 2 USB, VGA, RJ45 (*optional*), Microphone, Line-In / Line-Out jacks, Standard ATX, AUX and 12V power.

1.3 Value-added Solutions

SoftwareAudio: On audio models, a digital audio CODEC, CMI-9738 supports 4-Ch output, and the SiS962L supports the Sony/Philips Digital Interface (S/PDIF) Output module for coaxial and fiber interfaces. Experience surround sound and enhanced 3D audio.

Smart Card Reader Support: A special connector for the Smart Card Reader comes onboard to support the cutting-edge technology for increased security in authenticating online transactions, editing IC-based information.

USB2.0: The latest connection standard for next generation components and peripherals. Compatible with 1.1 USB, the new 2.0 USB protocol delivers transfer speeds up to 40 times faster at 480Mb/s.

NOTICE: USB 2.0 functions are not supported under Win98 and WinME.

Temperature, Fan and Voltage Monitoring: CPU temperature is monitored by the ASUS ASIC through the CPU's internal thermal diode to prevent overheating and damage. All system fans are monitored for RPM and failure. System voltage levels are monitored to ensure stable voltage to critical motherboard components.

Auto Fan Off: The system fans powers off automatically even in sleep mode.

ACPI Ready: Advanced Configuration Power Interface (ACPI) provides more Energy Saving Features for operating systems that support OS Direct Power Management (OSPM).

Onboard LAN (*Optional*): The motherboard incorporates the RTL8201L PHY chip to support 10BASE-T/100BASE-TX Fast Ethernet networking.

Concurrent PCI: Concurrent PCI allows multiple PCI transfers from PCI master busses to the memory and processor.

Dual Function Power Button: Push the power button for less than 4 seconds when the system is operating places the system into sleep or soft-off modes, depending on the BIOS or OS setting. If the power button is pressed for more than 4 seconds, the system enters soft-off mode.

1.4 Motherboard Components

Before installing the P4S533-VM motherboard, take time to familiarize yourself with its configuration: understanding the motherboard makes upgrading easy. Sufficient knowledge of specifications prevents accidental damage.

	Location
Processor Support	Socket 478 for Intel® P4™ Processors 2
Chipsets	SiS® 651 North Bridge 3
	SiS® 962L South Bridge 12
	2Mbit Programmable Flash EEPROM 18
	Multi-I/O Controller 19
	Audio Controller 22
Main Memory	2 DDR SDRAM DIMM Sockets (2GB) 5
Expansion Slots	3 PCI Slots 20
	Accelerated Graphics Port (AGP) 4X Slot 23
System I/O	Floppy Disk Drive Connector 15
	2 IDE Connectors (UltraDMA133 Support) 6
	Serial IRQ Connector 7
	System Panel Connector 9
	Infrared Connector 11
	USB Headers (USB_34, USB_56) 14
	Serial (COM2) Header 16
	Smart Card Connector 17
	Modem Connector 25
	Parallel Port 29
	Game Port 30
	Serial Port (COM1) 35
	USB Connectors (Port 1/2) 36
	PS/2 Mouse Connector (green) 27
	PS/2 Keyboard Connector (purple) 37
Hardware Monitoring	System Voltage Monitor (<i>integrated in ASUS ASIC</i>) 10
Special Feature	Onboard LED 13
Network Feature	Realtek 100/10 Mbps LAN PHY 26
	RJ45 Connector (<i>Optional</i>) 28
Audio Features	(<i>on audio models only</i>)
	Audio Controller Chipset 22
	SPDIF-out Connector 8
	Front Panel Audio Header 21
	Audio Connectors 24
	Line Out Connector (lime) 33
	Line In Connector (light blue) 32
	Microphone Connector (pink) 31
Power	ATX 12V Power Supply Connector 1
	ATX Power Supply Connector 4
Form Factor	micro-ATX

1.4.1 Component Locations

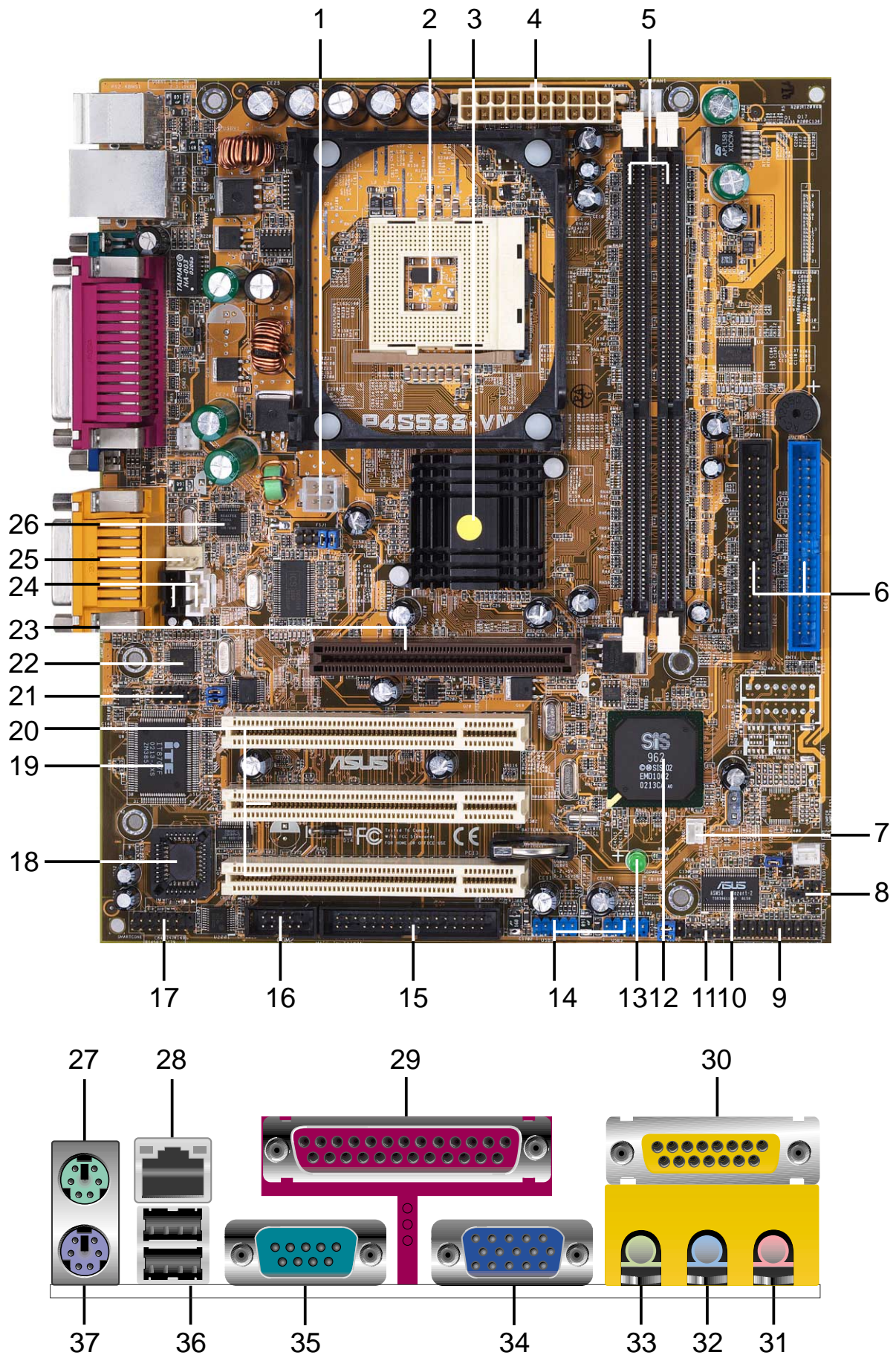



Chapter 2

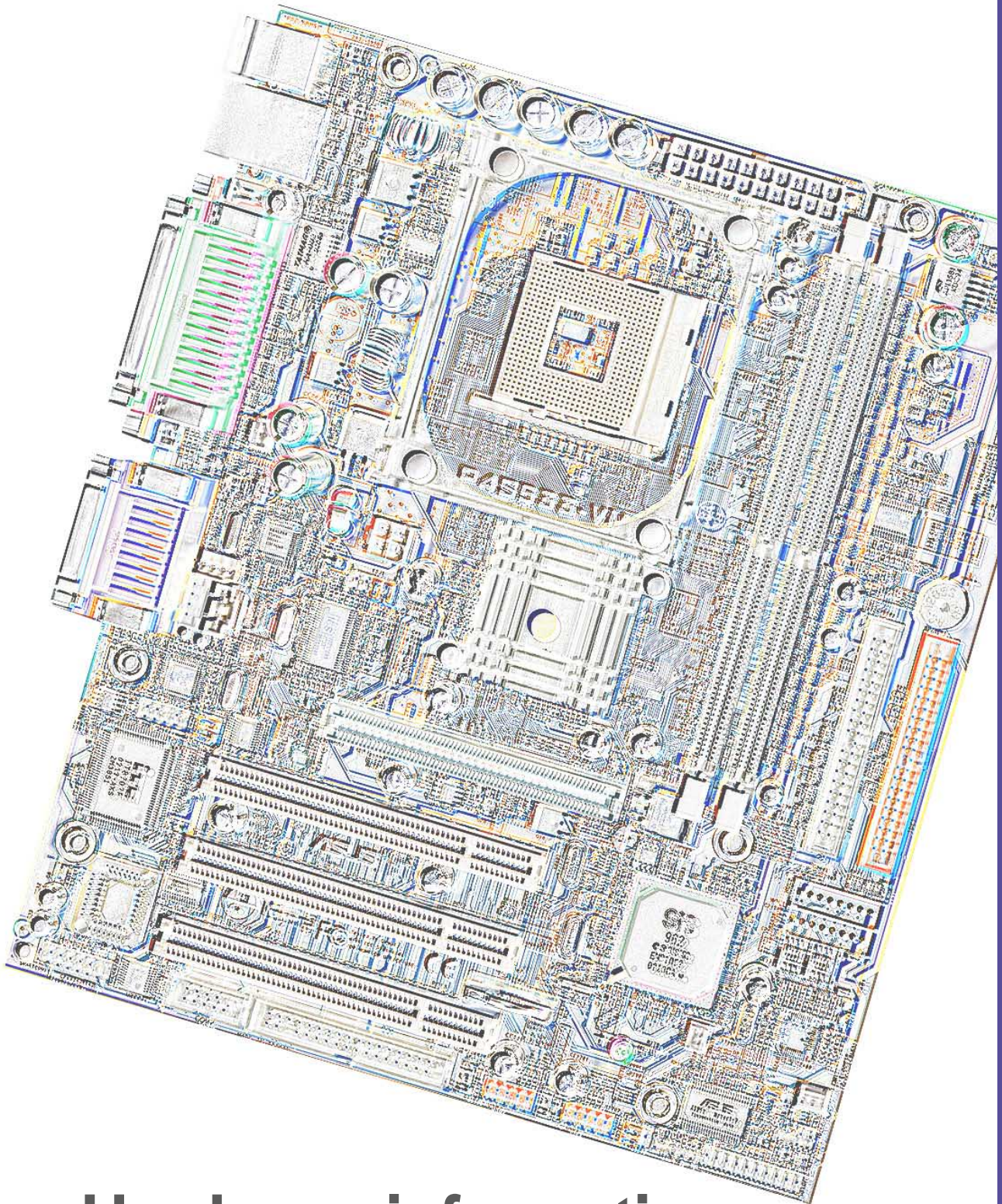

Hardware information

2.1 Motherboard installation

Before you install the motherboard, study the configuration of your chassis to ensure that the motherboard fits into it. The P4S533-VM uses the micro-ATX form factor that measures 24.4 cm (9.6 in.) x 20.9 cm (8.2 in.), a standard fit for most chassis.



Make sure to unplug the power cord before installing or removing the motherboard. Failure to do so may cause you physical injury and damage motherboard components.

2.1.1 Placement direction

When installing the motherboard, make sure that you place it into the chassis in the correct orientation. The edge with external ports goes to the rear part of the chassis. Refer to the image below.

2.1.2 Screw holes

Place six (6) screws into the holes indicated by circles to secure the motherboard to the chassis.



Do not overtighten the screws! Doing so may damage the motherboard.

Place this side towards
the rear of the chassis

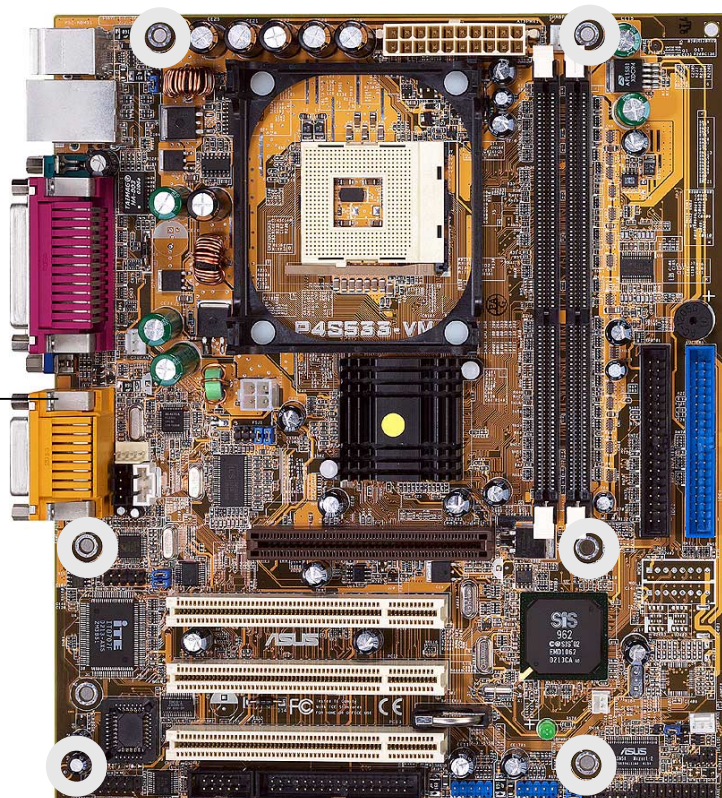

2.2 Motherboard layout

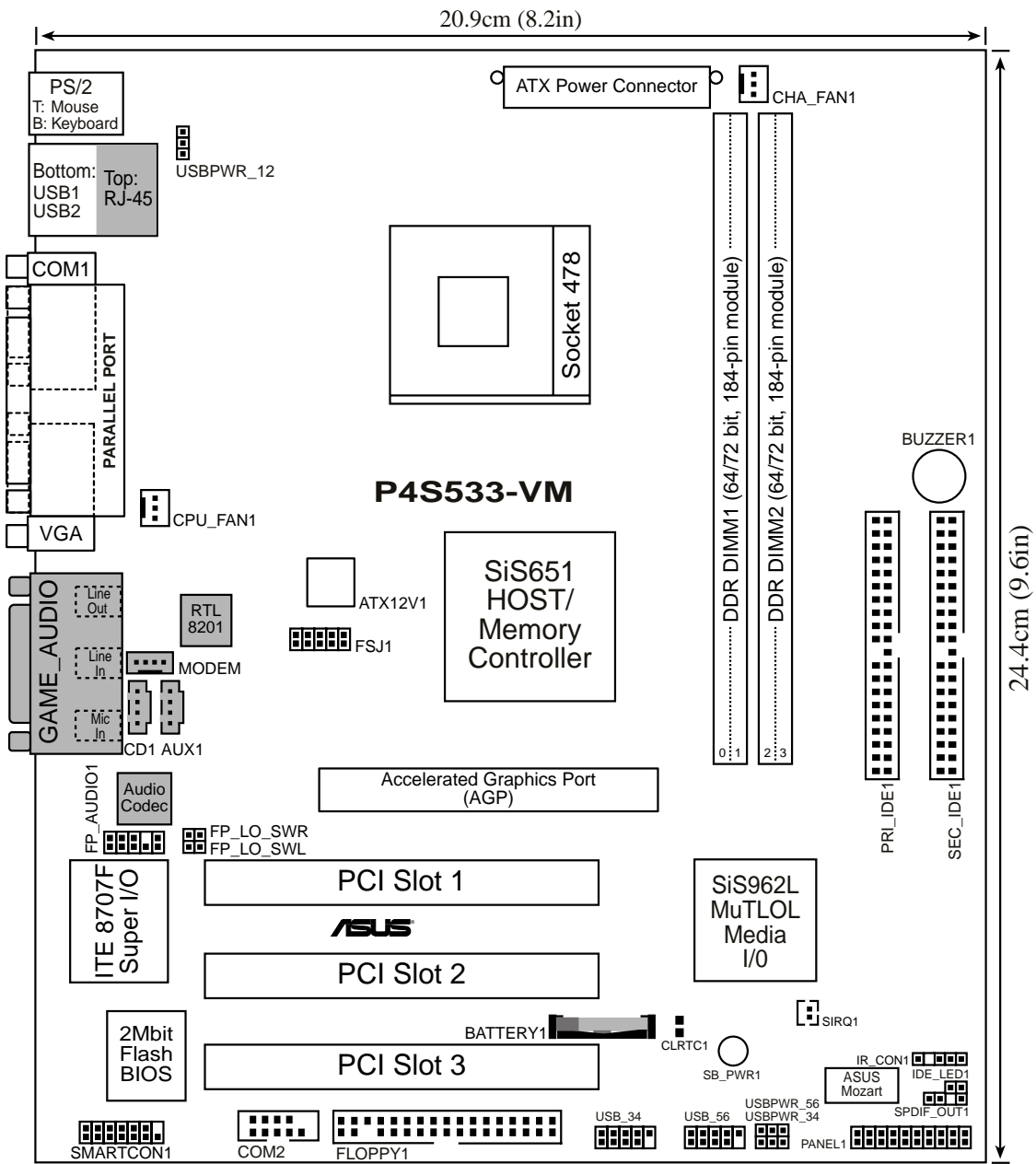

The audio and LAN features are optional. These components are grayed out in the above motherboard layout.

2.2.1 Layout contents

CPU, Memory and Expansion Slots

- | | |
|---------------|---------------------------------------|
| 1) Socket 478 | p. 12 Installing the CPU |
| 2) Heatsink | p. 14 Installing the Heatsink and Fan |
| 3) Memory | p. 17 System Memory Support |
| 4) PCI 1/2/3 | p. 21 32-bit PCI Bus Expansion Slots |
| 5) AGP 4x | p. 23 Accelerated Graphics Slot |

Motherboard Settings (Switches and Jumpers)

- | | |
|------------------------|---|
| 1) FSJ1 | p. 24 Frequency Selection (Jumpers 1–5) |
| 3) USBPWR_12, _34, _56 | p. 25 USB Device Wake-up (+5V / +5VSB) |
| 4) FP_LO_SWR, _SWL | p. 26 Line out selector (2x2 pin) |
| 5) CLRRTC1 | p. 27 Clear RTC RAM (Solder Points) |

Connectors

- | | |
|------------------------|---|
| 1) PS2KBMS | p. 29 PS/2 Mouse Port (6 pin female) |
| 2) PS2KBMS | p. 29 PS/2 Keyboard Port (6 pin female) |
| 3) USB | p. 30 Universal Serial Bus Ports 1 & 2 (2 x 4 pin female) |
| 4) PRINTER | p. 30 Parallel Port (25 pin female) |
| 5) COM1/ 2 | p. 30 Serial Port and Header (9 pin male, 10-1 pin male) |
| 6) GAME_AUDIO | p. 31 Game/MIDI Ports (Gold 15 pin) |
| 7) AUDIO | p. 31 Audio Connectors (Three 1/8" jacks) |
| 8) VGA | p. 32 Monitor Output Connector (15 pin) |
| 9) RJ45 | p. 32 Fast-Ethernet Port Connector (4 pin female) |
| 10) IDELED | p. 32 IDE Activity LED (2 pin) |
| 11) PRIMARY / SEC. IDE | p. 33 IDE Connectors (Two 40-1 pin) |
| 12) FLOPPY | p. 34 Floppy Disk Drive Connector (34-1 pin) |
| 13) CHAS, CPUFAN1 | p. 34 Chassis and CPU Fan Connectors (Two 3 pin) |
| 14) ATXPWR | p. 35 ATX Power Supply Connector (20 pin) |
| 15) USB34, 56 | p. 36 USB Headers (Two 10-1 pin) |
| 16) CD1, AUX1, MODEM | p. 36 Internal Audio Connectors (Three 4-1 pin) (<i>optional</i>) |
| 17) SPDIF_OUT1 | p. 37 Digital Audio Connector (4-1 pin) |
| 18) IR1_CON1 | p. 37 Infrared module connector (5-1 pin) |
| 19) SMARTCON1 | p. 38 Smart Card Reader Connector (14-1 pin) |
| 20) FP_AUDIO1 | p. 38 Front panel audio connector (10-1 pin) |
| 21) SIRQ1 | p. 39 Serial IRQ connector (2 pin) (<i>optional</i>) |
| 22) PLED | p. 40 System Power LED Lead (3-1 pin) |
| 23) SPEAKER | p. 40 System Warning Speaker Lead (4 pin) |
| 24) MLED | p. 40 System Message LED Lead (2 pin) |
| 25) SMI | p. 40 System Management Interrupt Lead (2 pin) |
| 26) PWRSW | p. 40 ATX Power Switch / Soft-Off Switch Lead (2 pin) |
| 27) RESET | p. 40 Reset Switch Lead (2-pin) |

2.3 Before you proceed

Take note of the following precautions before you install motherboard components or change any motherboard settings.



-
1. Unplug the power cord from the wall socket before touching any component.
 2. Use a grounded wrist strap or touch a safely grounded object or to a metal object, such as the power supply case, before handling components to avoid damaging them due to static electricity.
 3. Hold components by the edges and do not touch the ICs on them.
 4. Whenever you uninstall any component, place it on a grounded antistatic pad or in the bag that came with the component.
 5. **Before you install or remove any component, ensure that the ATX power supply is switched off or the power cord is detached from the power supply.** Failure to do so may cause severe damage to the motherboard, peripherals, and/or components.
-

2.4 Central Processing Unit (CPU)

2.4.1 Overview

The motherboard comes with a surface mount 478-pin Zero Insertion Force (ZIF) socket. This socket is specifically designed for the Intel® Pentium® 4 478/Northwood Processor.

The Intel Pentium 4 Processor in the 478-pin package uses the Flip-Chip Pin Grid Array 2 (FC-PGA2) package technology, and includes the Intel® NetBurst™ micro-architecture. The Intel NetBurst micro-architecture features the hyper-pipelined technology, rapid execution engine, 400MHz system bus, and execution trace cache. Together, these attributes improve system performance by allowing higher processor frequencies, faster execution of integer instructions, and a data transfer rate of 3.2GB/s.

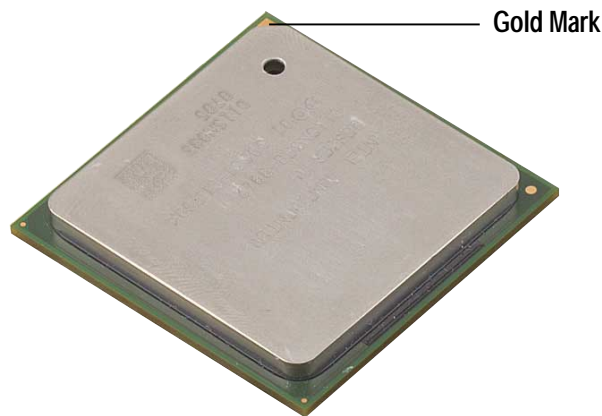

Note in the illustration that the CPU has a gold triangular mark on one corner. This mark indicates the processor Pin 1 that should match a specific corner of the CPU socket.



Incorrect installation of the CPU into the socket may bend the pins and severely damage the CPU!

2.4.2 Installing the CPU

Follow these steps to install a CPU.

1. Locate the 478-pin ZIF socket on the motherboard.

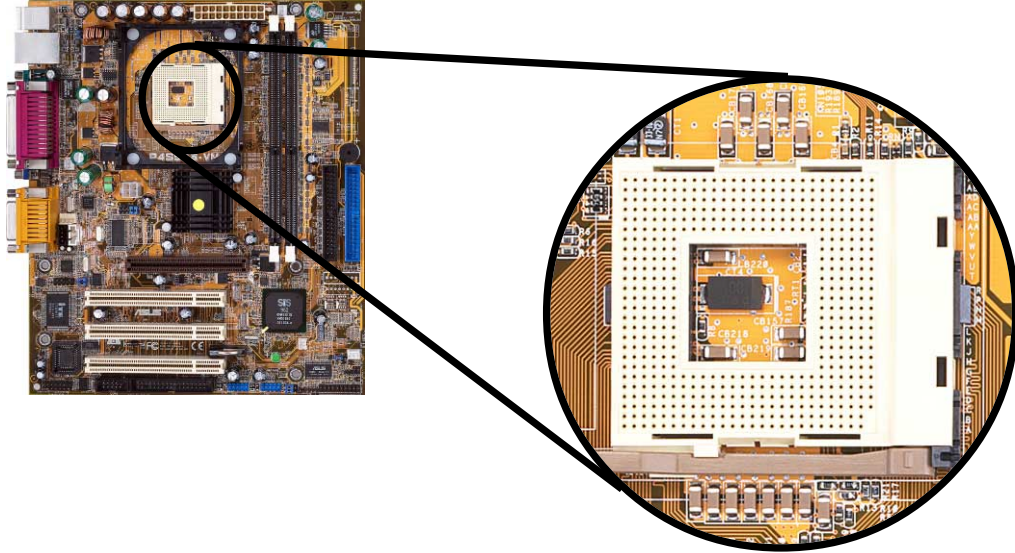

2. Unlock the socket by pressing the lever sideways, then lift it up to a 90°-100° angle.

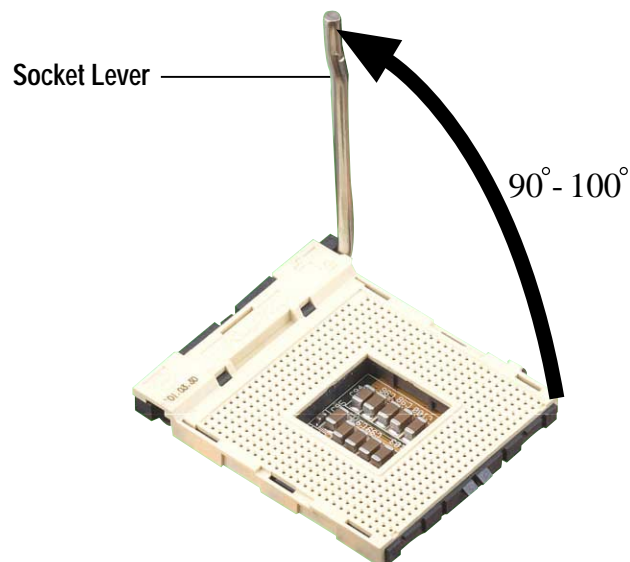

Make sure that the socket lever is lifted up to 90°-100° angle, otherwise the CPU does not fit in completely.

3. Position the CPU above the socket such that its marked corner matches the base of the socket lever.
4. Carefully insert the CPU into the socket until it fits in place.



The CPU fits only in one correct orientation. DO NOT force the CPU into the socket to prevent bending the pins and damaging the CPU!

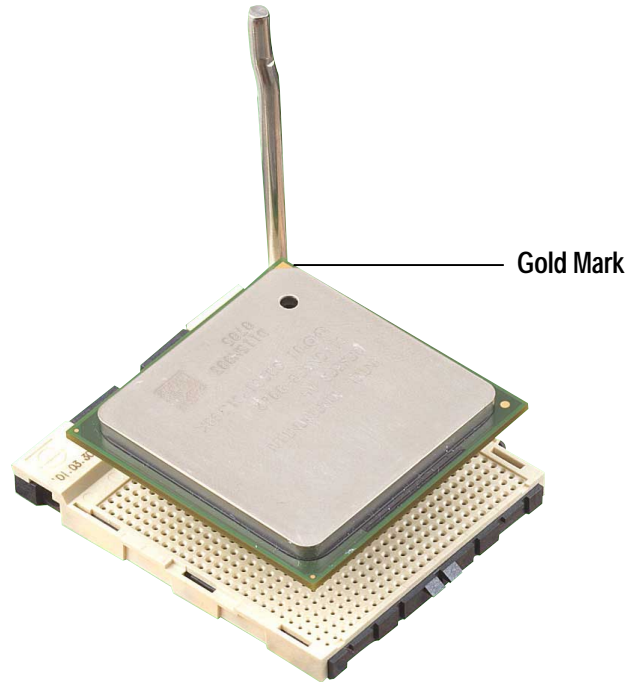

5. When the CPU is in place, press it firmly on the socket while you push down the socket lever to secure the CPU. The lever clicks on the side tab to indicate that it is locked.

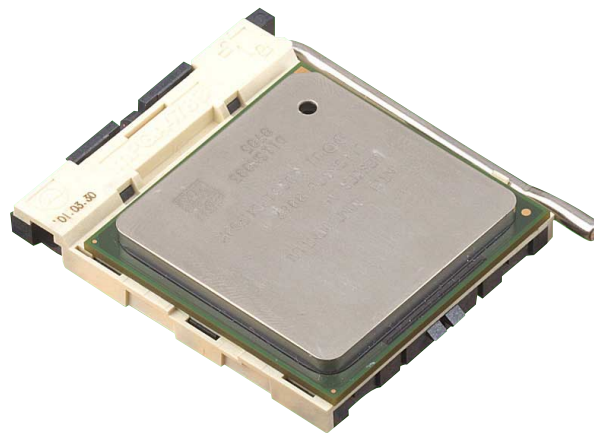

2.4.3 Installing the heatsink and fan

The Intel® Pentium® 4 478/Northwood Processor requires a specially designed heatsink and fan assembly to ensure optimum thermal condition and performance.



When you buy a boxed Intel Pentium 4 478/Northwood Processor, the package includes the heatsink, fan, and retention mechanism.

In case you buy a CPU separately, make sure that you use only Intel certified heatsink and fan.

Follow these steps to install the CPU heatsink and fan.

1. Place the heatsink on top of the installed CPU, making sure that the heatsink fits properly on the retention module base.



The retention module base is already installed on the motherboard upon purchase.

You do not have to remove the retention module base when installing the CPU or installing other motherboard components.

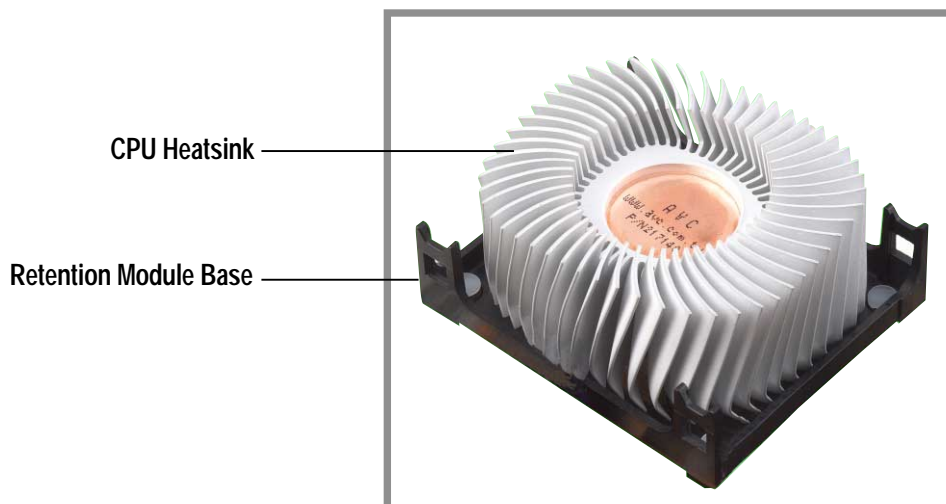

Your boxed Intel Pentium 4 478/Northwood Processor package should come with installation instructions for the CPU, heatsink, and the retention mechanism. If the instructions in this section do not match the CPU documentation, follow the latter.

2. Position the fan with the retention mechanism on top of the heatsink. Align and snap the four hooks of the retention mechanism to the holes on each corner of the module base.



Make sure that the fan and retention mechanism assembly perfectly fits the heatsink and module base, otherwise you cannot snap the hooks into the holes.

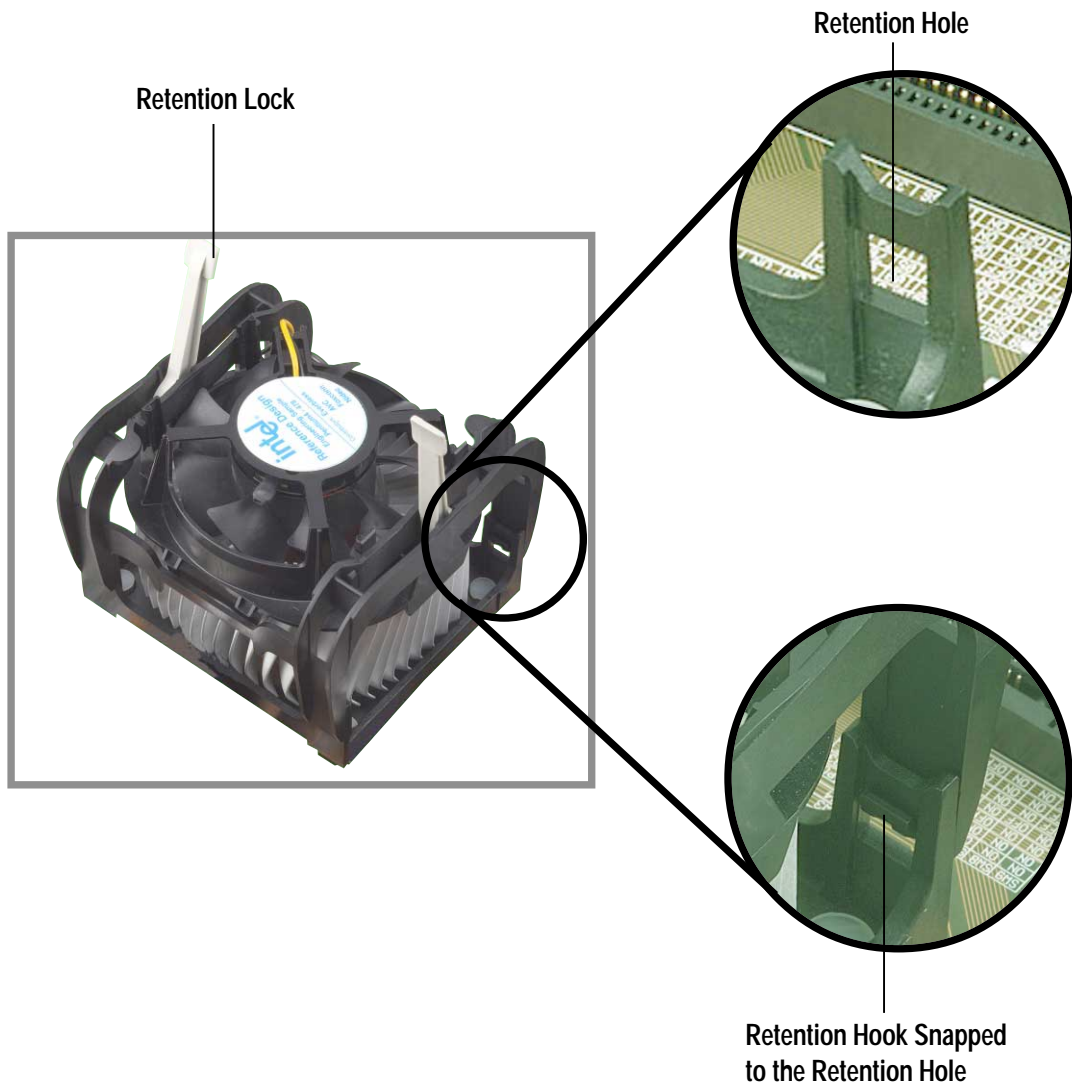

Keep the retention locks lifted upward while fitting the retention mechanism to the module base.

3. Push down the locks on the retention mechanism to secure the heatsink and fan to the module base.



When secure, the retention locks should point to opposite directions.



2.4.4 Connecting the CPU fan cable

When the fan, heatsink, and the retention mechanism are in place, connect the CPU fan cable to the connector on the motherboard labeled CPUFAN1.

CPU Fan Connector (CPUFAN1)

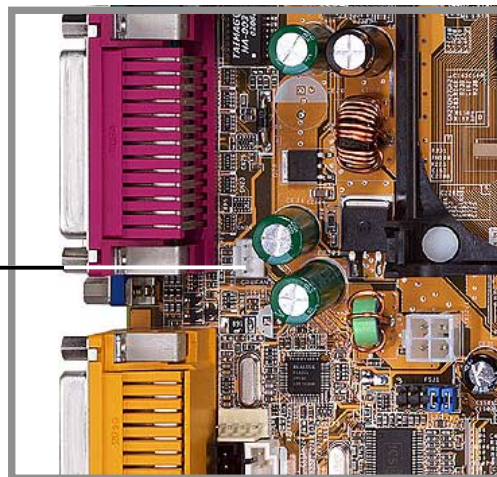

Don't forget to connect the CPU fan connector! Hardware monitoring errors may occur if you fail to plug this connector.

2.5 System memory

2.5.1 Overview

The motherboard comes with two Double Data Rate (DDR) Dual Inline Memory Module (DIMM) sockets. These sockets support up to 2GB system memory using 184-pin unbuffered non-ECC PC2700/2100/1600 DIMMs.

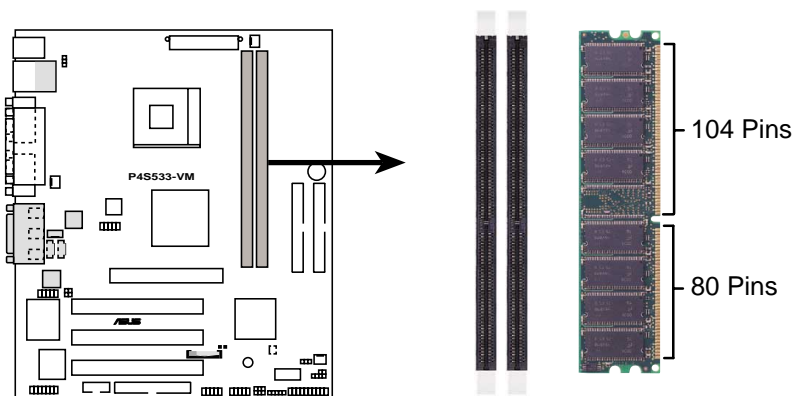

P4S533-VM 184-Pin DDR DIMM Sockets



A DDR DIMM is keyed with a notch so that it fits in only one direction. DO NOT force a DIMM into a socket to avoid damaging the DIMM.

The DDR SDRAM technology evolved from the mainstream PC66, PC100, PC133 memory known as Single Data Rate (SDR) SDRAM. DDR memory however, has the ability to perform two data operations in one clock cycle, thus providing twice the throughput of SDR memory.

DDR Data Transfer Rate		DDR Base Frequency
2.7 GB/s	➔	166MHz
2.1 GB/s	➔	133MHz
1.6 GB/s	➔	100MHz

A DDR DIMM has the same physical dimensions as an SDR DIMM, but it has a 184-pin footprint compared to the 168-pin of the SDR DIMM. Also, a DDR DIMM is single notched while an SDR DIMM is double notched. Therefore, a DDR DIMM is not backward compatible with SDR, and should be installed only in a socket specially designed for DDR DIMMs.

2.5.2 Memory configurations

You may install any DDR DIMMs with 64MB, 128MB, 256MB, 512MB and 1GB densities into the two DIMM sockets.

Use the following three combinations to install DDR DIMMs.

DIMM Location	184-pin DDR DIMM	Total Memory
Socket 1 (Rows 0&1)	64MB, 128MB, 256MB, 512MB, 1GB	x1 =
Socket 2 (Rows 2&3)	64MB, 128MB, 256MB, 512MB, 1GB	x1 =
Total system memory (Max. 2GB)		=

DDR333 DIMM Qualified Vendor List

The following table lists the DDR333 memory modules that have been tested and qualified for use with this motherboard.

Vendor	Model	Type/Size
Nanya	NT5DS16M8AT-6	PC2700/256MB
Samsung	K4H280838D-TCB3	PC2700/128MB
Samsung	K4H280838D-TCB3	PC2700/256MB
Micron	MT8VDDT1664AG-335B1	PC2700/128MB
Micron	MT16VDDT3264AG-335B1	PC2700/256MB
KINGMAX	MPMA82D-68KX3	PC2700/128MB
KINGMAX	MPM62D-68KX3	PC2700/256MB



Use only the tested and qualified DDR333 DIMMs listed above. Other DDR DIMMs manufactured by other vendors may not be suitable for this motherboard. Visit the ASUS website for the latest qualified DDR module list.

2.5.3 Installing a DIMM



Make sure to unplug the power supply before adding or removing DIMMs or other system components. Failure to do so may cause severe damage to both the motherboard and the components.

Follow these steps to install a DIMM.

1. Unlock a DIMM socket by pressing the retaining clips outward.
2. Align a DIMM on the socket such that the notch on the DIMM matches the break on the socket.

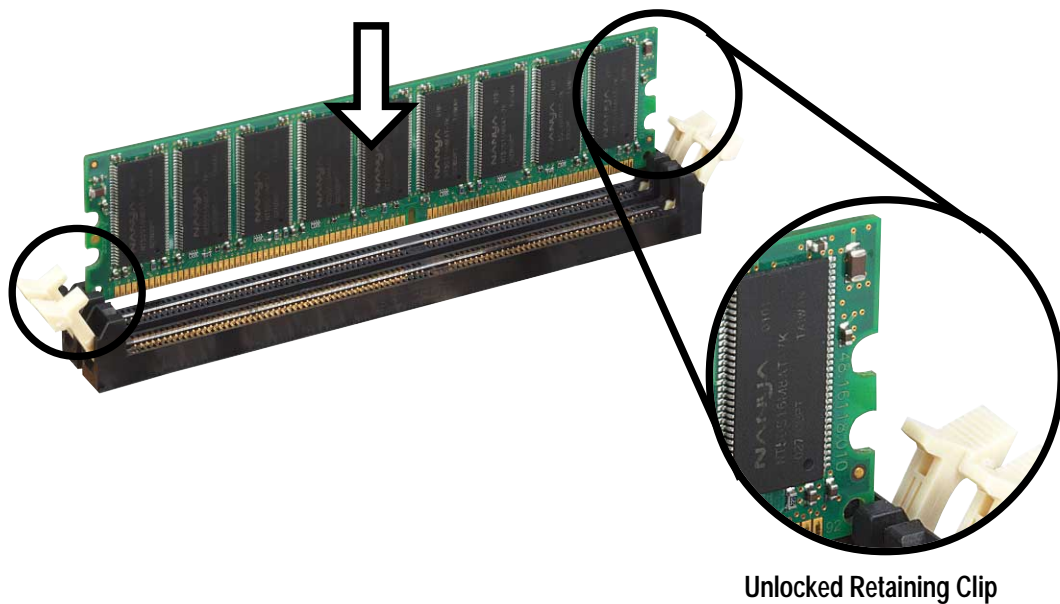

Unlocked Retaining Clip

3. Firmly insert the DIMM into the socket until the retaining clips snap back in place and the DIMM is properly seated.

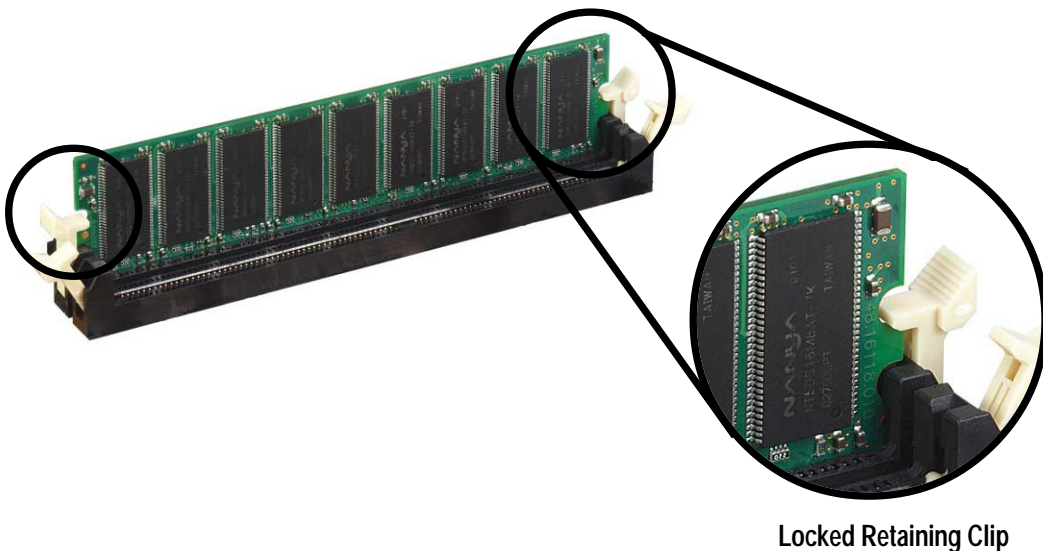

Locked Retaining Clip

2.5.4 Removing a DIMM

Follow these steps to remove a DIMM.

1. Simultaneously press the retaining clips outward to unlock the DIMM.



Support the DIMM lightly with your fingers when pressing the retaining clips. The DIMM might get damaged when it flips out with extra force.

2. Remove the DIMM from the socket.

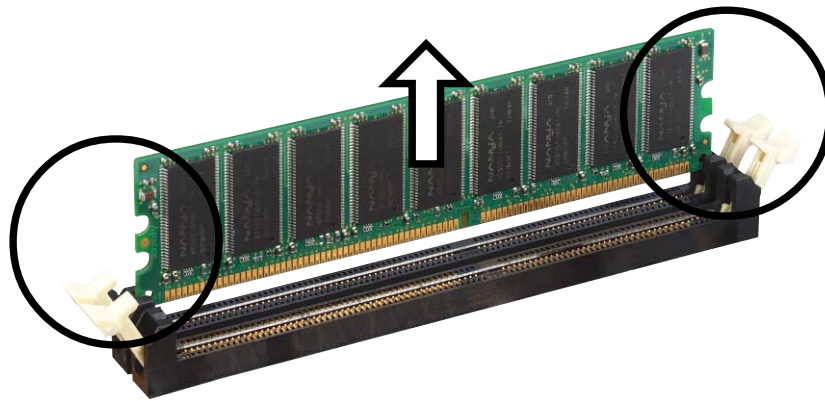

2.6 Expansion slots

In the future, you may need to install expansion cards. The motherboard has three PCI slots and one Accelerated Graphics Port (AGP) slot. The following sub-sections describe the slots and the expansion cards that they support.



Make sure to unplug the power cord before adding or removing expansion cards. Failure to do so may cause you physical injury and damage motherboard components.

2.6.1 Installing an expansion card

Follow these steps to install an expansion card.

1. Before installing the expansion card, read the documentation that came with it and make the necessary hardware settings for the card.
2. Remove the system unit cover (if your motherboard is already installed in a chassis).
3. Remove the bracket opposite the slot that you intend to use. Keep the screw for later use.
4. Align the card connector with the slot and press firmly until the card is completely seated on the slot.
5. Secure the card to the chassis with the screw you removed earlier.
6. Replace the system cover.

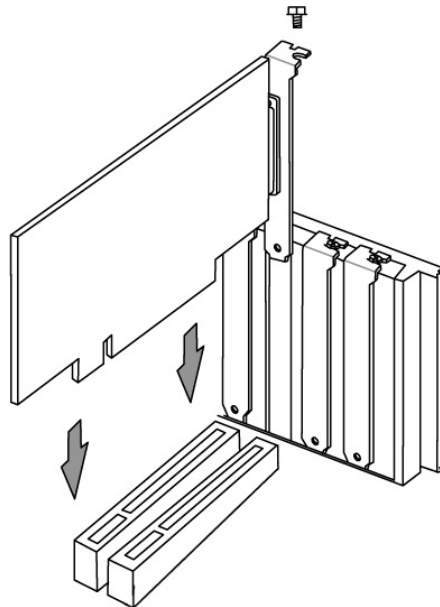

2.6.2 Configuring an expansion card

After physically installing the expansion card, configure the card by adjusting the software settings.

1. Turn on the system and change the necessary BIOS settings, if any. See Chapter 4 for information on BIOS setup.
2. Assign an IRQ to the card. Refer to the tables on the next page.
3. Install the software drivers for the expansion card.

Standard Interrupt Assignments

IRQ	Priority	Standard Function
0	1	System Timer
1	2	Keyboard Controller
2	N/A	Programmable Interrupt
3*	11	Communications Port (COM2)
4*	12	Communications Port (COM1)
5*	13	Sound Card (sometimes LPT2)
6	14	Floppy Disk Controller
7*	15	Printer Port (LPT1)
8	3	System CMOS/Real Time Clock
9*	4	ACPI Mode when used
10*	5	IRQ Holder for PCI Steering
11*	6	IRQ Holder for PCI Steering
12*	7	PS/2 Compatible Mouse Port
13	8	Numeric Data Processor
14*	9	Primary IDE Channel
15*	10	Secondary IDE Channel

*These IRQs are usually available for ISA or PCI devices.

IRQ assignments for this motherboard

	A	B	C	D	E	F	G	H
PCI slot 1	—	used	—	—	—	—	—	—
PCI slot 2	—	—	shared	—	—	—	—	—
PCI slot 3	—	—	—	used	—	—	—	—
Onboard USB HC0	—	—	—	—	used	—	—	—
Onboard USB HC1	—	—	—	—	—	used	—	—
Onboard USB HC2	—	—	—	—	—	—	used	—
Onboard USB HC3	—	—	—	—	—	—	—	used
AGP	shared	—	—	—	—	—	—	—
Onboard audio	—	—	shared	—	—	—	—	—
Onboard LAN	shared	—	—	—	—	—	—	—
Onboard VGA	shared	—	—	—	—	—	—	—



When using PCI cards on shared slots, ensure that the drivers support “Share IRQ” or that the cards do not need IRQ assignments.

2.6.3 PCI slots

There are three 32-bit PCI slots in this motherboard. The slots support PCI cards such as a LAN card, SCSI card, USB card, and other cards that comply with PCI specifications. The following figure shows a LAN card installed on a PCI slot.

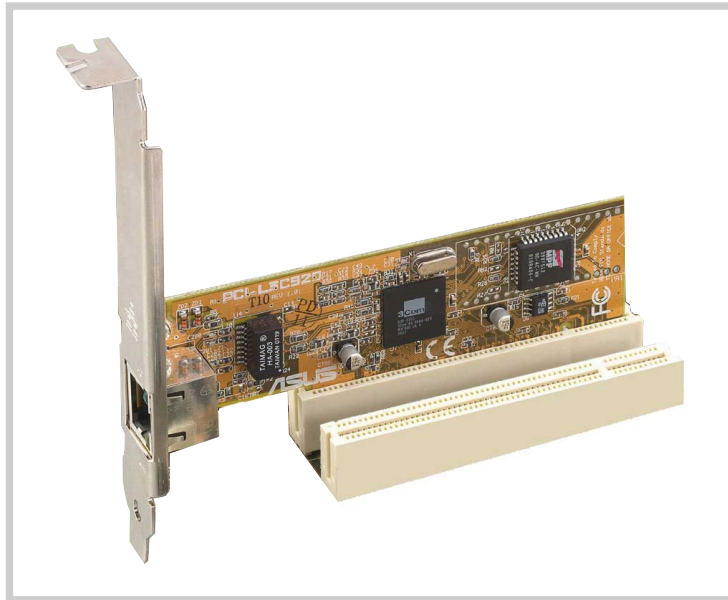

2.6.4 AGP slot

This motherboard has an Accelerated Graphics Port (AGP) slot that supports any AGP 4X/2X cards.

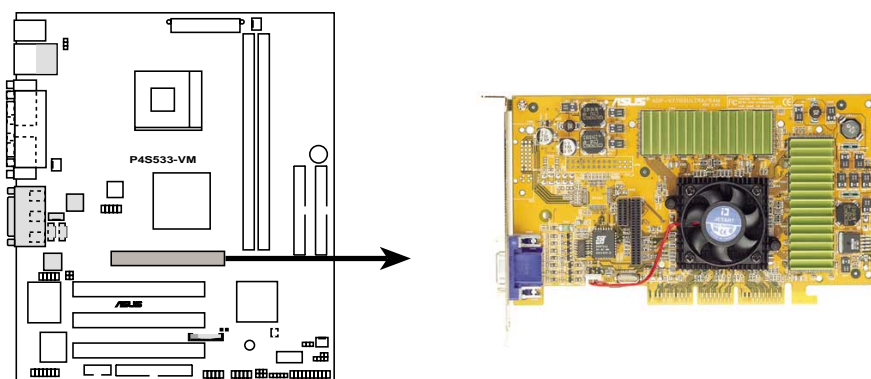

P4S533-VM Accelerated Graphics Port (AGP)



CAUTION! To avoid damaging your AGP/AGP Pro graphics card, your computer's power supply should be unplugged before inserting your graphics card into the slot.

2.7 Jumpers

The jumpers on the motherboard allow you to change some feature settings to suit your customized system configuration.

Motherboard Frequency Settings (FSJ Jumpers)

The motherboard frequency is adjusted through the FSJ jumpers.



Before changing any FSJ or jumper setting, make sure to read the jumper descriptions and setting requirements in this section.

1. CPU External Frequency Selection (FSJ1 Jumpers 1–5)

This option tells the clock generator which frequency to send to the CPU and DRAM. This allows the selection of the CPU's *External* frequency (or *BUS Clock*). The BUS Clock multiplied by the Frequency Multiple equals the CPU's *Internal* frequency (the advertised CPU speed).

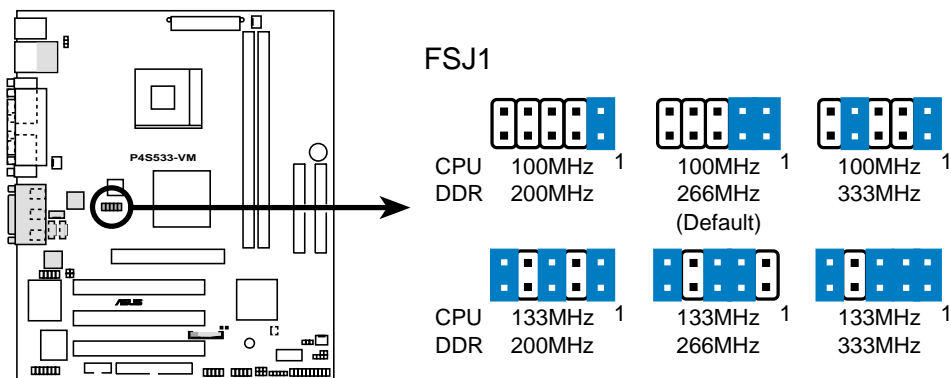

**P4S533-VM CPU
External Frequency Selection**

Frequency Table

MHz		FSJ1				
CPU	DRAM	5	4	3	2	1
100	200	[OFF]	[OFF]	[OFF]	[OFF]	[ON]
100	266	[OFF]	[OFF]	[OFF]	[ON]	[ON]
100	333	[OFF]	[ON]	[OFF]	[OFF]	[ON]
133	200	[ON]	[OFF]	[ON]	[OFF]	[ON]
133	266	[ON]	[OFF]	[ON]	[ON]	[OFF]
133	333	[ON]	[OFF]	[ON]	[ON]	[ON]



WARNING! Set the CPU AND DRAM frequencies only to the recommended settings. Frequencies other than the recommended CPU bus frequencies are not guaranteed to be stable. Overclocking the processor is not recommended, as it may result in a slower speed.

2. USB Device Wake-Up (USBPWR_12, _34, _56)

The default setting, [1-2] (+5V) disables the USB wake-up feature. Reset these jumpers to pins [2-3] (+5VSB) to wake up the computer using USB devices.



The USB device wake-up feature requires a power supply that can provide at least 1A on the +5VSB lead. If this requirement is not met, the system does not power up. The total current consumed must NOT exceed the power supply capability (+5VSB) whether under normal condition or in sleep mode. Also note that ONLY USB +5VSB can support S3 resume function.

Setting	+5V (default)	+5VSB
USBPWR_12	[1-2]	[2-3]
USBPWR_34	[1-2]	[2-3]
USBPWR_56	[1-2]	[2-3]

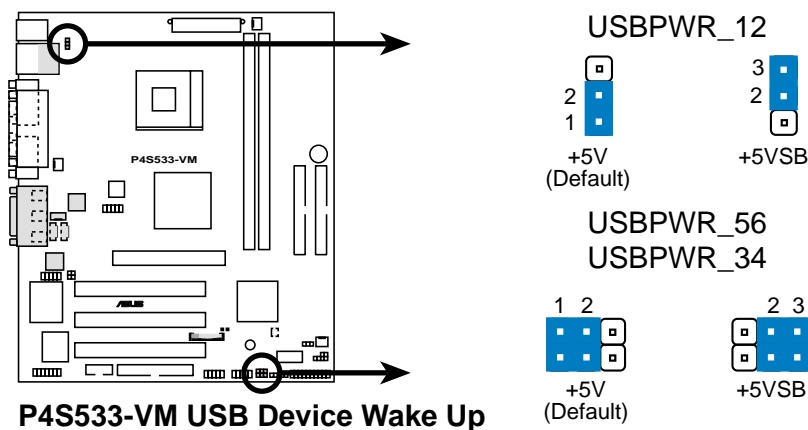

CAUTION! It is advisable not to increase the CPU voltage excessively to prevent premature failure and/or poor CPU performance.

3. Line out selector (FP_LO_SWR, FP_LO_SWL) (on audio models only)

By default, these jumpers are shorted (jumper caps on) to route the signal from the audio controller to the rear panel Line Out jack to make it available for audio out devices like speakers or headphones.

If you connect the Intel Front Panel audio cable to the FP_Audio connector (see page 38 for the location), remove the caps from these jumpers to allow automatic switching of audio signals between the rear panel Line Out jack and the audio cable.

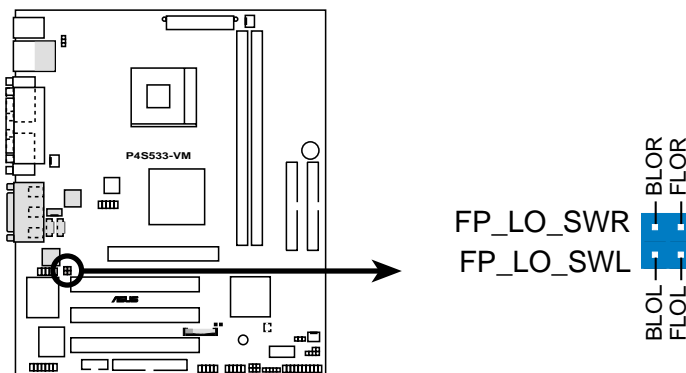

P4S533-VM Internal Line Out Connectors

4. Clear RTC RAM (CLRTC1)

These solder points allow you to clear the Real Time Clock (RTC) RAM in CMOS. You can clear the CMOS memory of date, time, and system setup parameters by erasing the CMOS RTC RAM data. The RAM data in CMOS, that include system setup information such as system passwords, is powered by the onboard button cell battery.

To erase the RTC RAM:

1. Turn OFF the computer and unplug the power cord.
2. Remove the motherboard battery.
3. Short the solder points using a delicate metal implement like a paper-clip.
4. Replace the battery.
5. Plug the power cord and turn ON the computer.
6. Hold down the key during the boot process and enter BIOS setup to re-enter data.

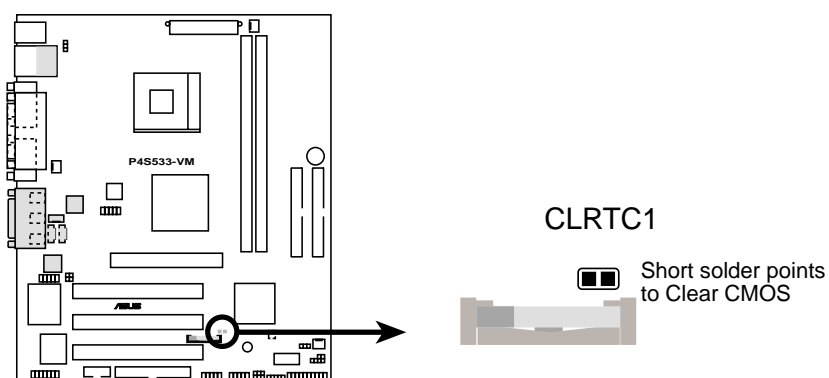

P4S533-VM Clear RTC RAM Setting

2.8 Connectors

This section describes and illustrates the internal connectors on the motherboard.



WARNING! Some pins are used for connectors or power sources. These are clearly distinguished from jumpers in the Motherboard Layout. Placing jumper caps over these connector pins will cause damage to your motherboard.



IMPORTANT! Ribbon cables should always be connected with the red stripe to Pin 1 in the connector socket.

1. PS/2 Mouse Port (Green, 6-pin PS2KBMS)

The system automatically directs IRQ12 to the PS/2 mouse if one is detected. If no mouse is detected, IRQ12 become available to expansion cards. See **PS/2 Mouse Function Control** in **4.4 Advanced Menu**.

PS/2 Mouse (6-pin female)

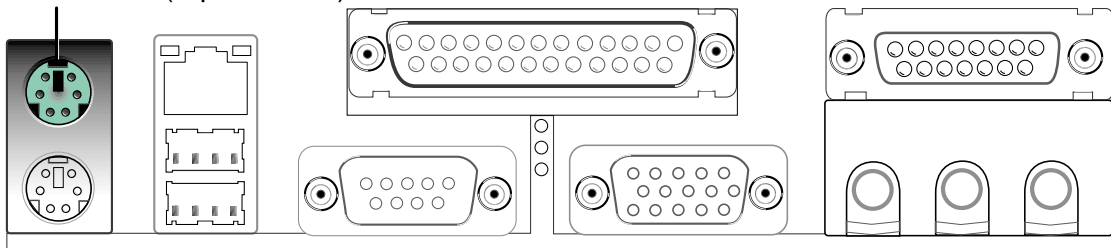

2. PS/2 Keyboard Port (Purple, 6-pin PS2KBMS)

This connection is for a standard keyboard using an PS/2 plug (mini DIN). This connector does not allow standard AT size (large DIN) keyboard plugs. You may use a DIN to mini DIN adapter on standard AT keyboards.

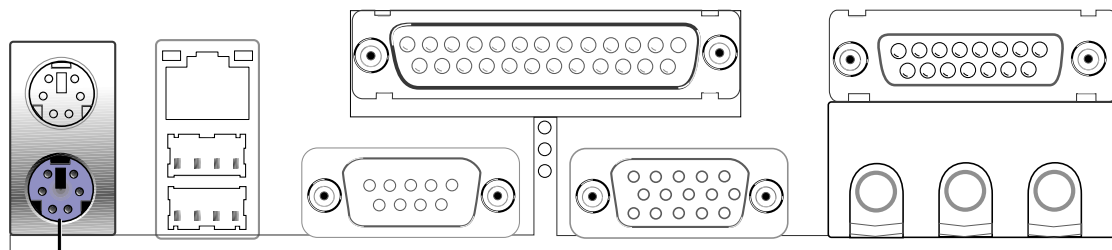

PS/2 Keyboard (6-pin female)

3. Universal Serial Bus Ports 1 and 2 (Black, Two x 4-pin USB)

Four USB ports are available for connecting USB devices.

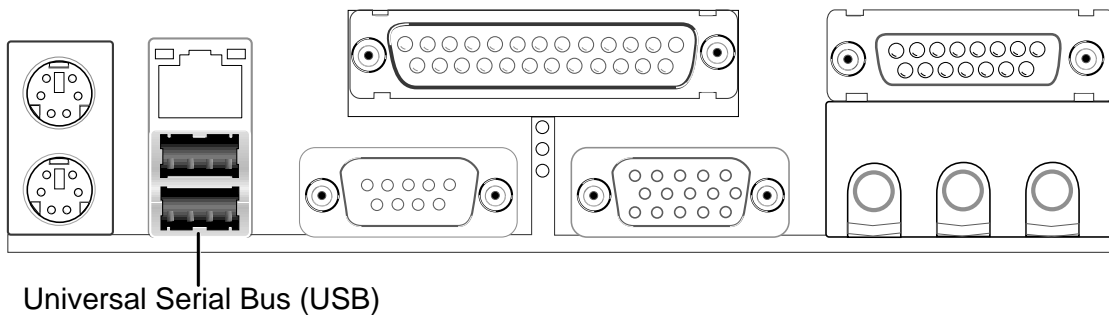

4. Parallel Port (Burgundy 25-pin PRINTER)

You can enable the parallel port and choose the IRQ through **Onboard Parallel Port** (see **4.4.2 I/O Device Configuration**).



NOTE! Serial printers must be connected to the serial port.

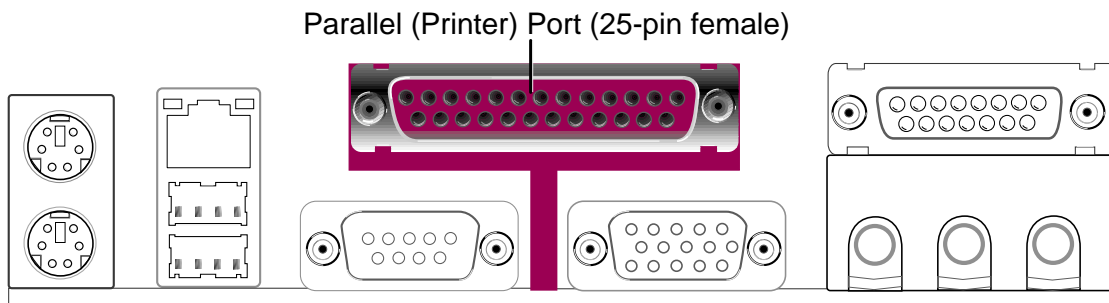

5. Serial Port and Header (Teal/Turquoise 9-pin COM1, 10-1 pin COM2)

One serial port can be used for pointing devices, printers or other serial devices. An onboard header supports a serial bracket. To enable these ports, see **Onboard Serial Port 1** in **4.4.2 I/O Device Configuration** for the settings.

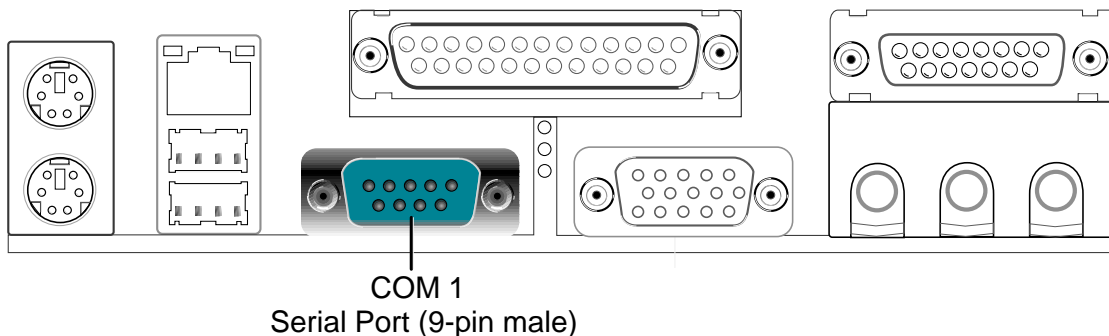

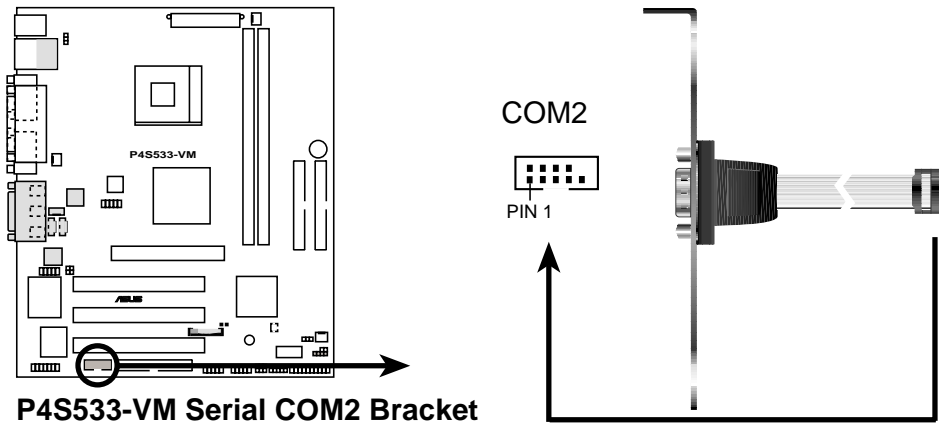

6. Game/MIDI Ports (Gold 15-pin GAME_AUDIO) (optional)

This connector supports a joystick or a game pad for playing games, and MIDI devices for playing or editing audio files.

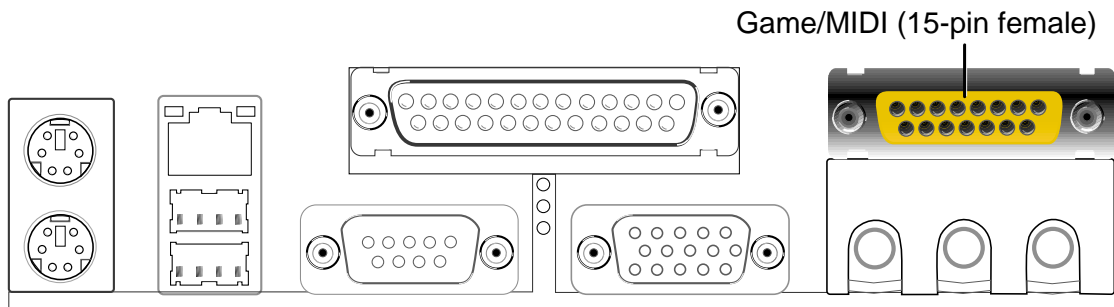

7. Audio Connectors (Three 1/8" AUDIO) (optional)

The **Line Out** (lime) connects a headphone or speakers. The **Line In** (light blue) connects a tape players or other audio sources. The **Mic** (pink) connects a microphone.



NOTE! The functions of the audio connectors Line Out, Line In, and Mic change when the 6-channel audio feature is enabled. Refer to **Chapter 5. SOFTWARE SETUP.**

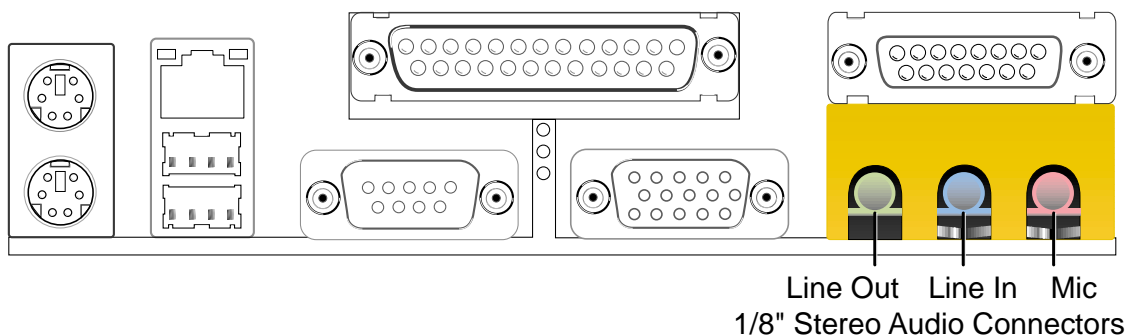

8. Monitor Output Connector (Blue 15 pin VGA)

This connector supports a VGA-compatible device.

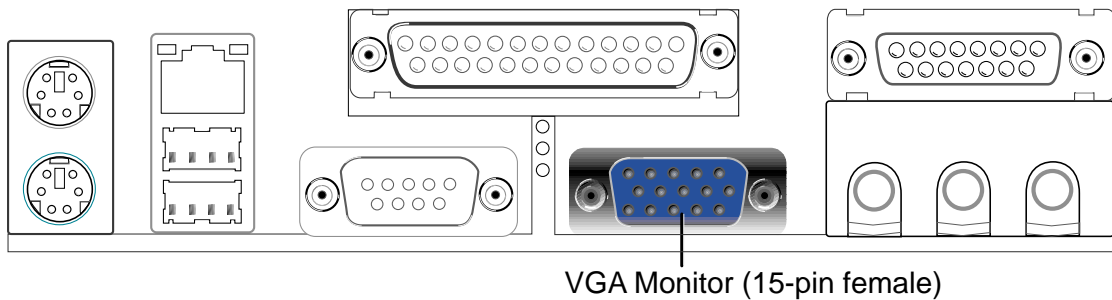

9. Fast-Ethernet Port Connector (RJ45) (optional)

This RJ45 connector is located on top of the USB Ports 0 & 1. The RJ45 supports connectivity for local area networks.

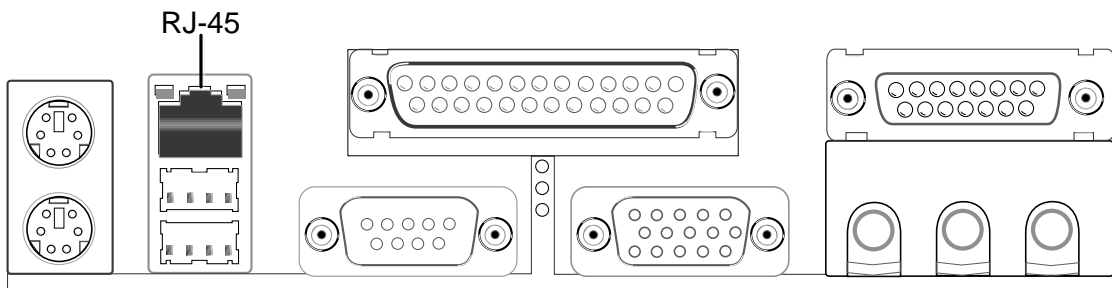

10. IDE Activity LED (2-pin IDELED)

This connector supplies power to the hard disk activity LED. The read or write activities of any device connected to the primary or secondary IDE connector cause this LED to light up.

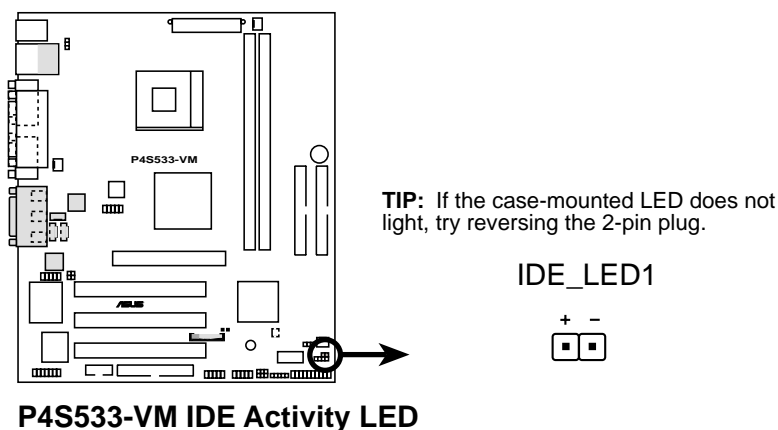

Some pins are used for connectors or power sources. These are clearly distinguished from jumpers in the Motherboard Layout. Placing jumper caps over these connector pins will cause damage to your motherboard.

11. IDE Connectors (40-pin PRI_IDE1 / SEC_IDE1)

This connector supports the provided UltraDMA133/100/66 IDE hard disk ribbon cable. Connect the cable's blue connector to the PRI_IDE1 (recommended) or to the SEC_IDE1 connector; then connect the gray connector to the UltraDMA133/100/66 slave device (hard disk drive) and the black connector to the UltraDMA133/100/66 master device. It is recommended that you connect non-UltraDMA133/100/66 devices to the secondary IDE connector. If you install two hard disks, you must configure the second drive as a slave device by setting its jumper accordingly. Refer to the hard disk documentation for the jumper settings. BIOS supports specific device bootup. If you have more than two UltraDMA133/100/66 devices, purchase another UltraDMA133/100/66 cable. You may configure two hard disks to be both master devices with two ribbon cables – one for the primary IDE connector and another for the secondary IDE connector.



1. Pin 20 on each IDE connector is removed to match the covered hole on the UltraDMA cable connector. This prevents incorrect orientation when you connect the cables.
2. The hole near the blue connector on the UltraDMA133/100/66 cable is intentional.

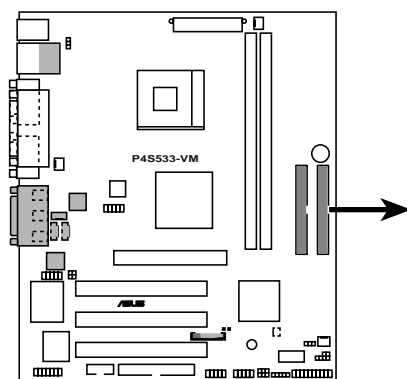

P4S533-VM IDE Connectors

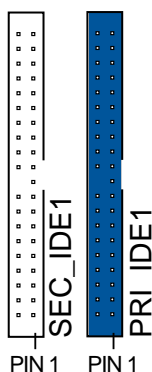

NOTE: Orient the red markings on the IDE ribbon cable to PIN 1



For UltraDMA133/100/66 IDE devices, use an 80-conductor IDE cable. The UltraDMA/66 cable included in the motherboard package also supports UltraDMA133.



Always connect ribbon cables with the red stripe to Pin 1 on the connectors. Pin 1 is usually on the side closest to the power connector on hard drives and CD-ROM drives, but may be on the opposite side on floppy disk drives.

12. Floppy disk drive connector (34-1 pin FLOPPY)

This connector supports the provided floppy drive ribbon cable. After connecting one end to the motherboard, connect the other end to the floppy drive. (Pin 5 is removed to prevent incorrect insertion when using ribbon cables with pin 5 plug).

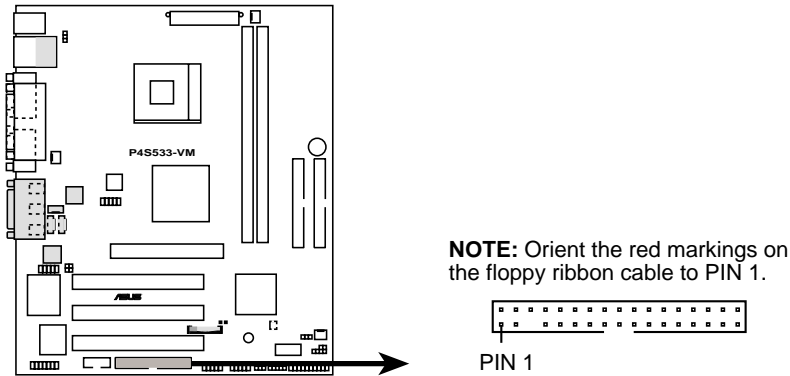

P4S533-VM Floppy Disk Drive Connector

13. CPU and Chassis Fan Connectors (2x3-pin CHAFAN1, CPUFAN1)

The two fan connectors support cooling fans of 350mA (4.2 Watts) or a total of 1A (12W) at +12V. Orient the fans so that the heat sink fins allow air flow to go across the onboard heat sinks instead of the expansion slots. The fan wiring and plug may vary depending on the fan manufacturer. Connect the fan cable to the connector matching the black wire to the ground pin.



Do not forget to connect the fan cables to the fan connectors. Lack of sufficient air flow within the system may damage the motherboard components. These are not jumpers! **DO NOT** place jumper caps on the fan connectors!

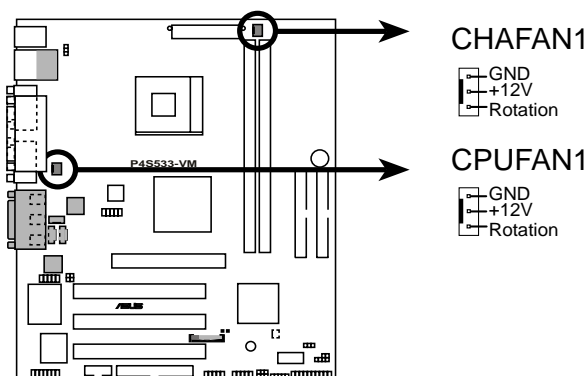

P4S533-VM 12-Volt Cooling Fan Power

14. ATX power connectors (20-pin ATXPWR1, 4-pin ATX12V1)

These connectors connect to an ATX 12V power supply. The plugs from the power supply are designed to fit these connectors in only one orientation. Find the proper orientation and push down firmly until the connectors completely fit.

In addition to the 20-pin ATXPWR connector, this motherboard requires that you connect the 4-pin ATX +12V power plug to provide sufficient power to the CPU.



Make sure that your ATX 12V power supply can provide at least 8A on the +12V lead and at least 1A on the +5-volt standby lead (+5VSB). The minimum recommended wattage is 230W, or 300W for a fully configured system. The system may become unstable and may experience difficulty powering up if the power supply is inadequate.

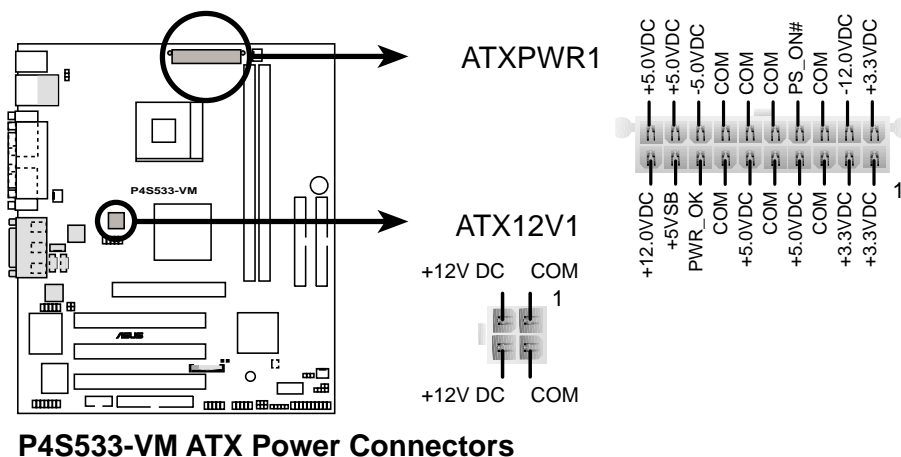

15. USB header (2x10-1 pin USB_34, _56)

If the USB port connectors on the rear panel are inadequate, a USB header is available for additional USB port connectors. Connect the bundled 2-port USB connector set to this header and mount the USB bracket to an open slot in the chassis.

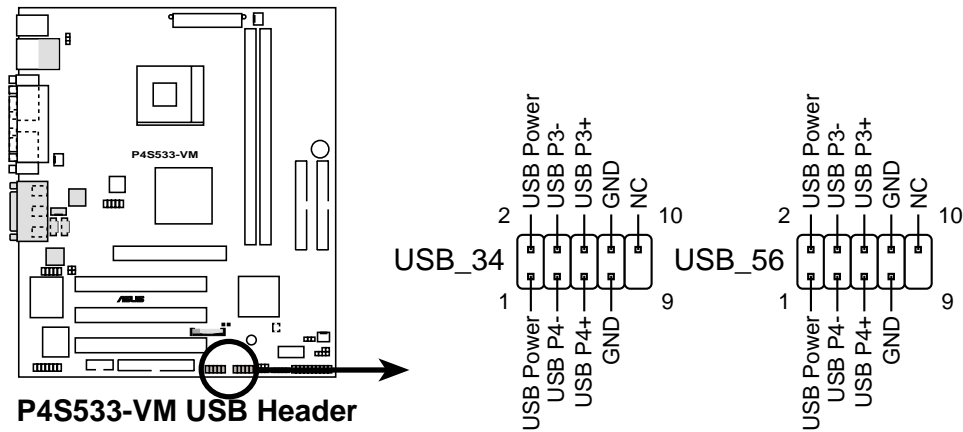

16. Internal audio connectors (4-pin CD1, AUX1, MODEM) (optional)

These connectors allow you to receive stereo audio input from sound sources such as a CD-ROM, TV tuner, or MPEG card. The MODEM connector allows the onboard audio to interface with a voice modem card with a similar connector. It also allows the sharing of mono_in (such as a phone) and a mono_out (such as a speaker) between the audio and a voice modem card.

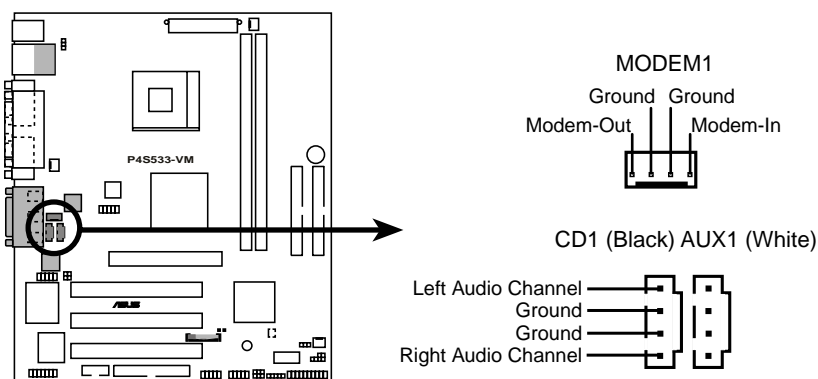

P4S533-VM Internal Audio Connectors

17. Digital audio connector (4-1 pin SPDIF_OUT1) (optional)

This connector connects an S/PDIF audio module that allows digital instead of analog sound output. Connect one end of the audio cable to the S/PDIF Out connector on the motherboard, and the other end to the S/PDIF module.



The S/PDIF module is not included in the motherboard package.

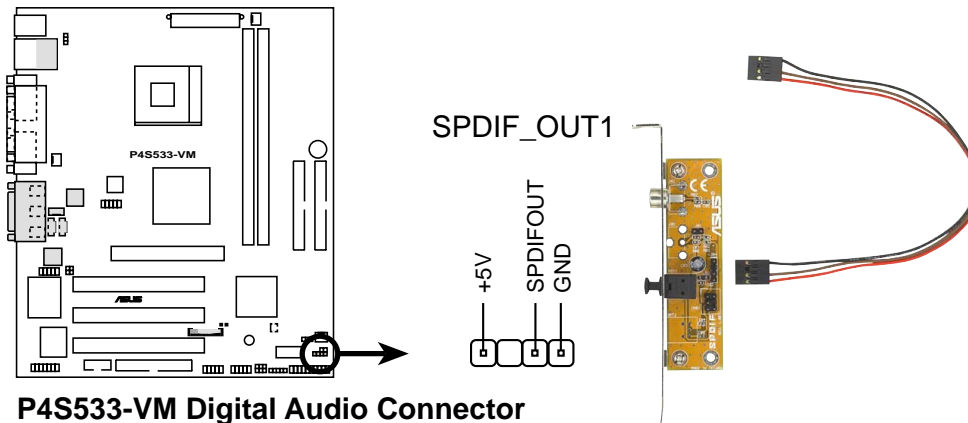

P4S533-VM Digital Audio Connector

18. Infrared module connector (5-1 pin IR_CON1)

This connector supports an optional wireless transmitting and receiving infrared module. This module mounts to a small opening on system chassis that support this feature. You must also configure the **UART2 Use As** parameter in BIOS to set UART2 for use with IR. See section “4.4.2 I/O Device Configuration” for details.

Use the five pins as shown in Back View and connect a ribbon cable from the module to the motherboard SIR connector according to the pin definitions.

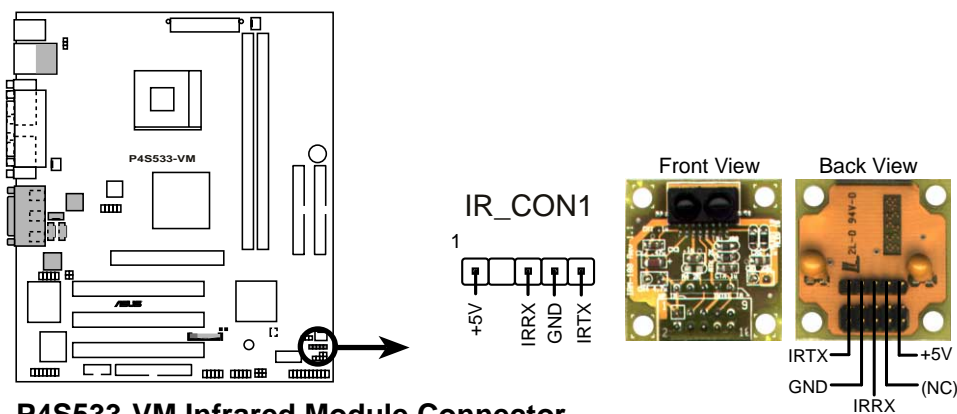

P4S533-VM Infrared Module Connector

19. Smart Card Reader connector (14-1 pin SMARTCON1) *(optional)*

This connector accommodates a Smart Card Reader that allows you to conveniently make transactions such as financial, health care, telephony, or traveling services through a Smart Card user interface software. When using this connector, configure the **UART2 Use As** parameter in BIOS to set UART2 for use with Smart Card. See section “4.4.2 I/O Device Configuration” for details.

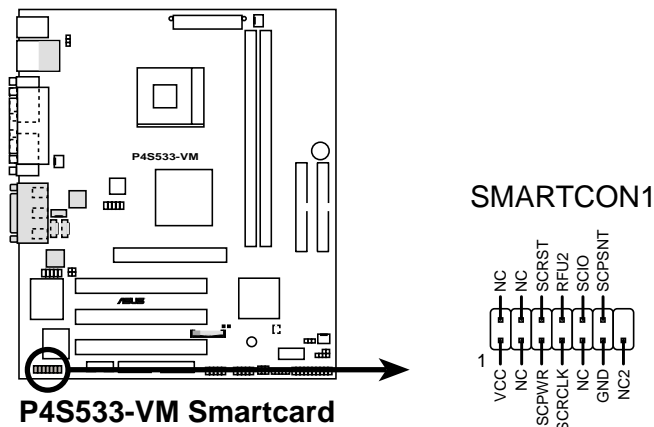

20. Front panel audio connector (10-1 pin FP_AUDIO1) *(on audio models only)*

This is an interface for the *Intel*® front panel audio cable that supplies convenient connection and control of audio devices.



Ensure that the jumper caps are removed from the FP_LO_SWR and FP_LO_SWL jumpers if you installed the Intel front panel audio cable. Refer to page 27 for the location of the audio jumpers.

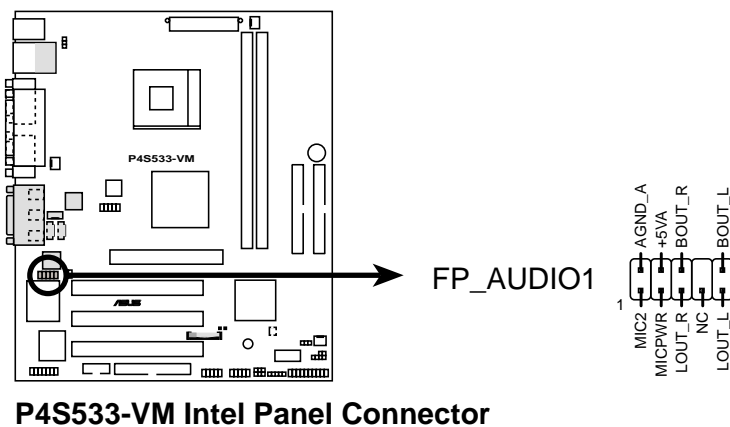

21. Serial IRQ connector (2 pin SIRQ1) *(optional)*

This connector supports the serial IRQ cable. This cable is required by some PCI cards like those with PCMCIA function.

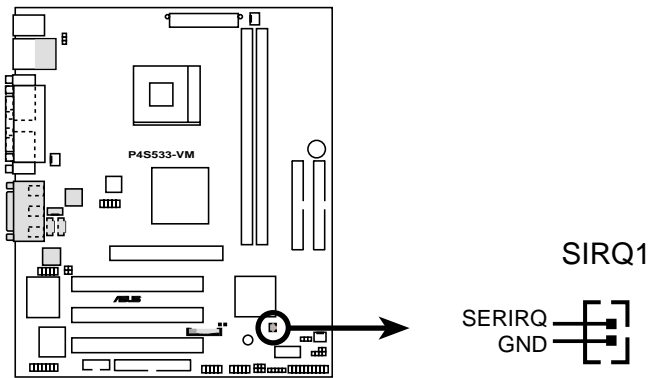

P4S533-VM SIRQ1 Connector

Panel Connector (20 pin PANEL)

The following diagram illustrates items 22-27:

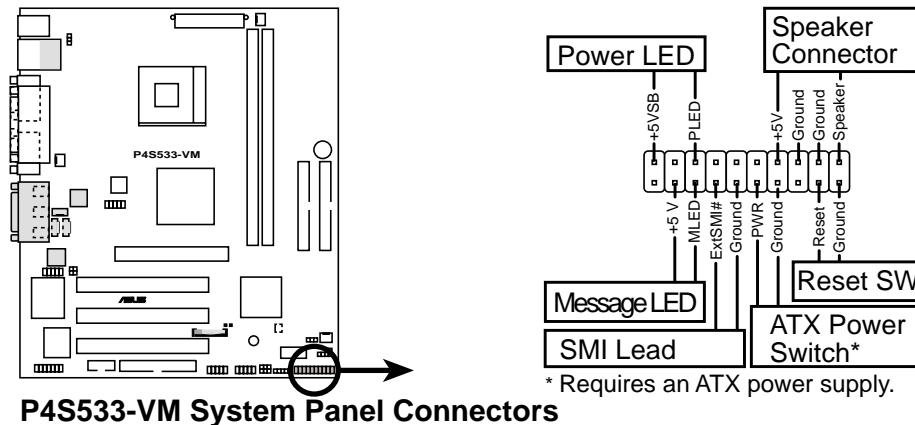

22. System Power LED Lead (3-1 pin PLED)

This connector supplies the system power LED. The LED lights up when the system power is on, and the LED blinks when the system is in sleep or soft-off mode.

23. System Warning Speaker Lead (4 pin SPEAKER)

This connector supplies the case-mounted speaker to sound system beeps and warnings.

24. System Message LED Lead (2 pin MLED)

This connector supports the system message LED to indicate receipt of messages from a fax/modem. The normal status for this LED is ON, when there is no incoming data signal. The LED blinks when data is received. The system message LED feature requires an ACPI OS and driver support.

25. System Management Interrupt Lead (2 pin SMI)

This connector permits switching to suspend mode, or “Green” mode: system activity is decreased to conserve power and system components. Attach the case-mounted suspend switch this 2-pin connector.

26. ATX Power Switch / Soft-Off Switch Lead (2 pin PWRSW)

The system power is controlled by a momentary switch attached to this connector. Pressing the button switches the system between ON and SLEEP, or ON and SOFT OFF, depending on the BIOS or OS settings. Pressing the button while in the ON mode for more than 4 seconds turns the system off.

27. Reset Switch Lead (2-pin RESET)

This connector supports the case-mounted reset switch for rebooting the system without turning off the power switch.

Chapter 3

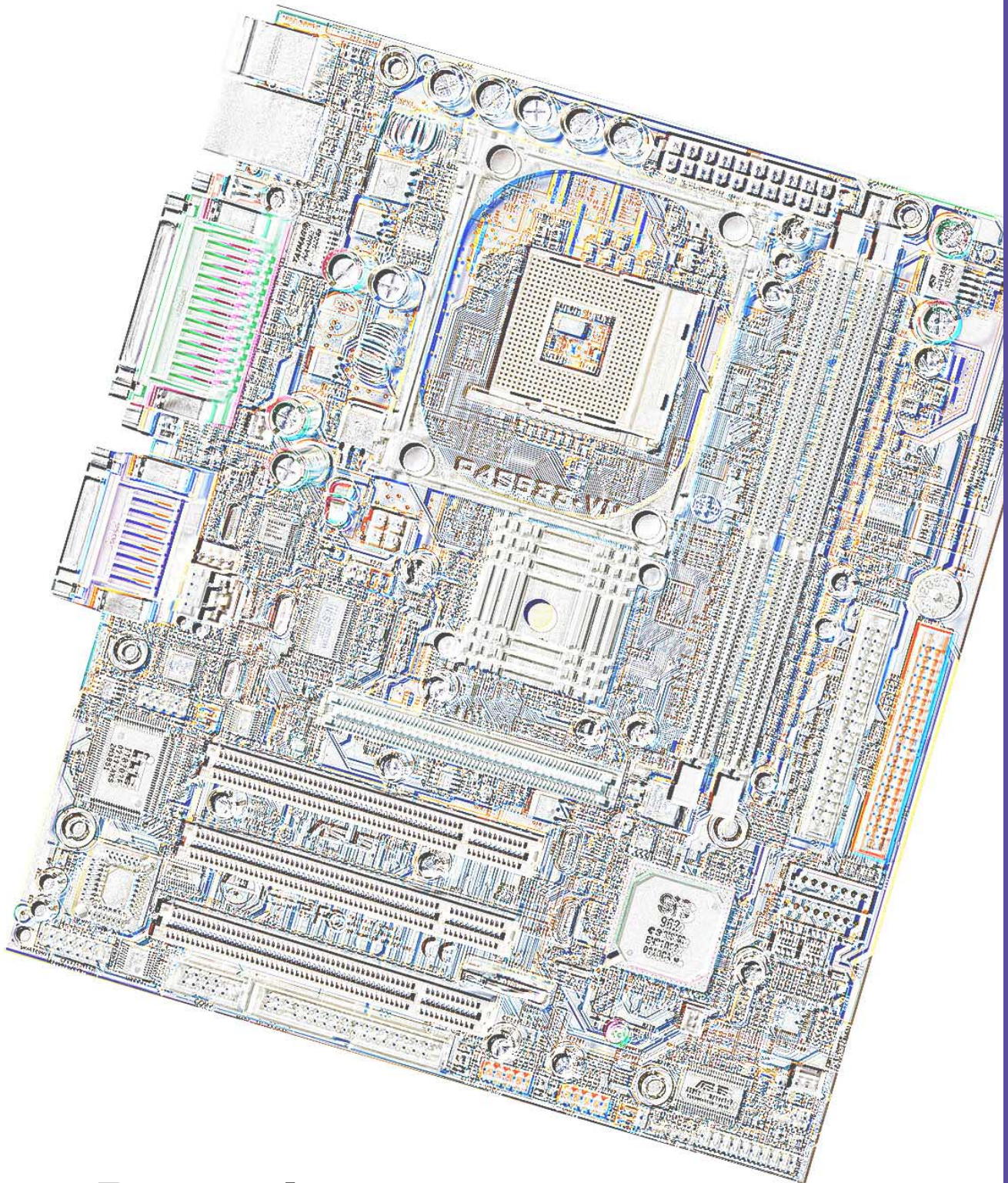

Powering up

3.1 Starting up for the first time

1. After making all the connections, replace the system case cover.
2. Be sure that all switches are off.
3. Connect the power cord to the power connector at the back of the system chassis.
4. Connect the power cord to a power outlet that is equipped with a surge protector.
5. Turn on the devices in the following order:
 - a. Monitor
 - b. External SCSI devices (starting with the last device on the chain)
 - c. System power (if you are using an ATX power supply, you need to switch on the power supply as well as press the ATX power switch on the front of the chassis).
6. After applying power, the power LED on the system front panel case lights up. For ATX power supplies, the system LED lights up when you press the ATX power switch. If your monitor complies with “green” standards or if it has a “power standby” feature, the monitor LED may light up or switch between orange and green after the system LED turns on. The system then runs the power-on tests. While the tests are running, the BIOS beeps or additional messages appear on the screen. If you do not see anything within 30 seconds from the time you turned on the power, the system may have failed a power-on test. Check the jumper settings and connections or call your retailer for assistance.

Award BIOS Beep Codes

Beep	Meaning
One short beep when displaying logo	No error during POST
Long beeps in an endless loop	No DRAM installed or detected
One long beep followed by three short beeps	Video card not found or video card memory bad
High frequency beeps when system is working	CPU overheated; System running at a lower frequency



You will not hear the BIOS beeps when the ASUS POST Reporter is enabled. You will hear the vocal POST messages instead.

7. At power on, hold down <Delete> to enter BIOS Setup. Follow the instructions in Chapter 4.

3.3 Powering off the computer

You must first exit the operating system and shut down the system before switching off the power. For ATX power supplies, you can press the ATX power switch after exiting or shutting down the operating system. If you use Windows 95/98/2000/XP, click the Start button, click Shut Down, then click the OK button to shut down the computer. The power supply should turn off after Windows shuts down.



The message “You can now safely turn off your computer” does not appear when shutting down with ATX power supplies.

Chapter 4

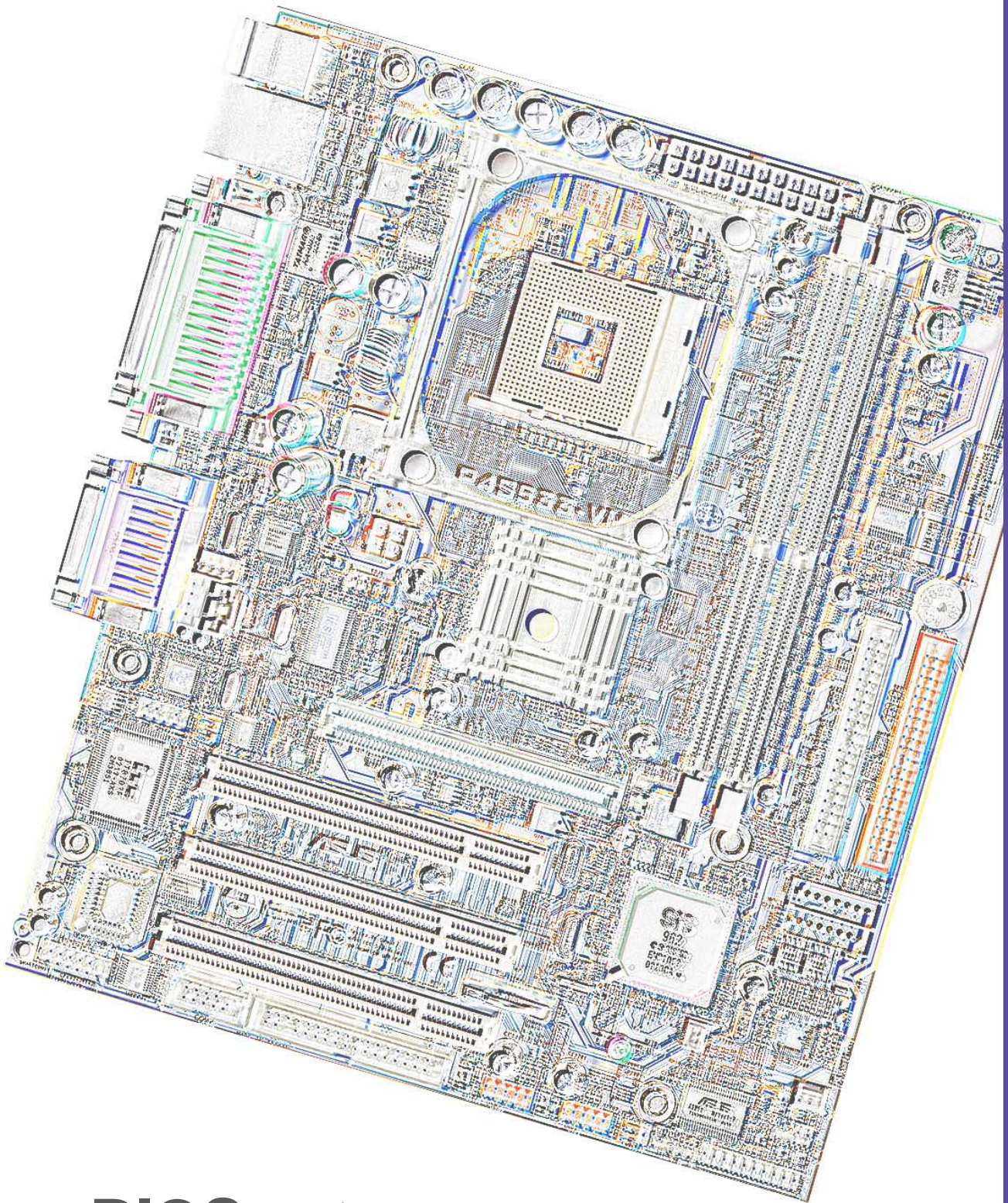

BIOS setup

4.1 Managing and updating your BIOS

4.1.1 Using the computer system for the first time

It is recommended that you save a copy of the original motherboard BIOS along with a Flash Memory Writer utility (AFLASH.EXE) to a bootable floppy disk in case you need to reinstall the BIOS later. AFLASH.EXE is a Flash Memory Writer utility that updates the BIOS by uploading a new BIOS file to the programmable flash ROM on the motherboard. This file works only in DOS mode. To determine the BIOS version of your motherboard, check the last four numbers of the code displayed on the upper left-hand corner of your screen during bootup. Larger numbers represent a newer BIOS file.

1. Type `FORMAT A:/S` at the DOS prompt to create a bootable system disk. DO NOT copy `AUTOEXEC.BAT` and `CONFIG.SYS` to the disk.
2. Type `COPY D:\AFLASH\AFLASH.EXE A:\` (assuming D is your CD-ROM drive) to copy `AFLASH.EXE` to the boot disk you created.



AFLASH works only in DOS mode. It does not work in the DOS prompt within Windows and does not work with certain memory drivers that may be loaded when you boot from the hard drive. It is recommended that you reboot using a floppy disk.

3. Reboot the computer from the floppy disk.



BIOS setup must specify “Floppy” as the first item in the boot sequence.

4. In DOS mode, type `A:\AFLASH <Enter>` to run AFLASH.

```
ASUS ACPI BIOS
FLASH MEMORY WRITER V1.29
Copyright (C) 1994-99, ASUSTeK COMPUTER INC.

Flash Memory: Winbond W29C020 or SST 29EE020 or Intel 82802AB

Current BIOS Version: ASUS XXX-XX ACPI BIOS Revision 100X
BIOS Model           : XXX-XX
BIOS Built Date      : 09/25/98

Choose one of the followings:

1. Save Current BIOS To File
2. Update BIOS Including Boot Block and ESCD

Enter choice: [1]

Press ESC To Exit
```



If the word “unknown” appears after Flash Memory:, the memory chip is either not programmable or is not supported by the ACPI BIOS and therefore, cannot be programmed by the Flash Memory Writer utility.

5. Select 1. Save Current BIOS to File from the Main menu and press <Enter>. The Save Current BIOS To File screen appears.

```
Save Current BIOS To File
Flash Memory: Winbond W29C020 or SST 29EE020 or Intel B2802AB
Current BIOS Version: ASUS XXX-XX ACPI BIOS Revision 100X
BIOS Model          : XXX-XX
BIOS Built Date     : 09/25/98
Please Enter File Name to Save: XXX-XX.XXX

BIOS Saved Successfully
Press ESC To Continue
```

6. Type a filename and the path, for example, A:\XXX-XX.XXX, then press <Enter>.

4.1.2 Updating BIOS procedures



Update the BIOS only if you have problems with the motherboard and you are sure that the new BIOS revision will solve your problems. Careless updating may result to more problems with the motherboard!

1. Download an updated ASUS BIOS file from the Internet (see the ASUS Contact Information on page x for details) and save to the boot floppy disk you created earlier.
2. Boot from the floppy disk.
3. At the "A:\>" prompt, type AFLASH and then press <Enter>.
4. At the Main Menu, type 2 then press <Enter>. The Update BIOS Including Boot Block and ESCD screen appears.
5. Type the filename of your new BIOS and the path, for example, A:\XXX-XX.XXX, then press <Enter>.

To cancel this operation, press <Enter>.

```
Update BIOS Including Boot Block and ESCD
Flash Memory: Winbond W29CB20 or SST 29EE020 or Intel 82802AB
Current BIOS Version: ASUS XXX-XX ACPI BIOS Revision 100X
BIOS Model      : XXX-XX
BIOS Built Date   : 09/25/98
Please Enter File Name for NEW BIOS: A:\XXX-XX.XXX
```

6. When prompted to confirm the BIOS update, press Y to start the update.

```
Update BIOS Including Boot Block and ESCD
Flash Memory: Winbond W29CB20 or SST 29EE020 or Intel 82802AB
BIOS Version
[CURRENT ] ASUS XXX-XX ACPI BIOS Revision 100X
[test.awd] ASUS XXX-XX ACPI BIOS Revision 100X
BIOS Model
[CURRENT ] XXX-XX
[test.awd] XXX-XX
Date of BIOS Built
[CURRENT ] 09/25/99
[XXXX.XXX] 05/29/00
Check sum of 1001.010 is F266.
Are you sure (Y/N) ? [Y]
Press ESC To Return to Main Menu
```

7. The utility starts to program the new BIOS information into the Flash ROM. The boot block is updated automatically only when necessary. This minimizes the possibility of boot problems in case of update failures. When the programming is done, the message “*Flashed Successfully*” appears.

```
Update BIOS Including Boot Block and ESCD
Flash Memory: Winbond W29C820 or SST 29EE020 or Intel 82802AB
BIOS Version
[CURRENT] ASUS XXX-XX ACPI BIOS Revision 100X
[test.awd] ASUS XXX-XX ACPI BIOS Revision 100X
BIOS Model
[CURRENT] XXX-XX
[test.awd] XXX-XX
Date of BIOS Built
[CURRENT] 09/25/99
[XXXX.XXX] 05/29/00
Check sum of 1001.010 is F266.
Are you sure (Y/N) ? [Y]
Block Erasing -- Done
Programming -- 3FFF
Flashed Successfully
Press ESC To Continue
```

8. Follow the onscreen instructions to continue.

```
ASUS ACPI BIOS
FLASH MEMORY WRITER V1.29
Copyright (C) 1994-99, ASUSTeK COMPUTER INC.
Flash Memory: Winbond W29C820 or SST 29EE020 or Intel 82802AB
Current BIOS Version: ASUS XXX-XX ACPI BIOS Revision 100X
BIOS Model : XXX-XX
BIOS Built Date : 05/29/99
Choose one of the followings:
1. Save Current BIOS To File
2. Update BIOS Including Boot Block and ESCD
Enter choice: [1]
You have flashed the EPROM:It is recommended that you turn off
the power, enter SETUP and LOAD Setup Defaults to have CMOS
updated with new BIOS when exits.
Press ESC To Exit
```



If you encounter problems while updating the new BIOS, DO NOT turn off the system because this may cause boot problems. Just repeat the process, and if the problem persists, load the original BIOS file you saved to the boot disk. If the Flash Memory Writer utility is not able to successfully update a complete BIOS file, the system may not boot. If this happens, call the ASUS service center for support.

4.2 BIOS Setup program

This motherboard supports a programmable EEPROM that you can update using the provided utility described in section “4.1 Managing and updating your BIOS.”

Use the BIOS Setup program when you are installing a motherboard, reconfiguring your system, or prompted to “Run Setup”. This section explains how to configure your system using this utility.

Even if you are not prompted to use the Setup program, you may want to change the configuration of your computer in the future. For example, you may want to enable the security password Feature or make changes to the power management settings. This requires you to reconfigure your system using the BIOS Setup program so that the computer can recognize these changes and record them in the CMOS RAM of the EEPROM.

The EEPROM on the motherboard stores the Setup utility. When you start up the computer, the system provides you with the opportunity to run this program. Press <Delete> during the Power-On Self Test (POST) to enter the Setup utility, otherwise, POST continues with its test routines.

If you wish to enter Setup after POST, restart the system by pressing <Ctrl> + <Alt> + <Delete>, or by pressing the reset button on the system chassis. You can also restart by turning the system off and then back on. Do this last option only if the first two failed.

The Setup program is designed to make it as easy to use as possible. It is a menu-driven program, which means you can scroll through the various sub-menus and make your selections among the predetermined choices.



Because the BIOS software is constantly being updated, the following BIOS setup screens and descriptions are for reference purposes only, and may not exactly match what you see on your screen.

4.2.1 BIOS menu bar

The top of the screen has a menu bar with the following selections:

- MAIN** Use this menu to make changes to the basic system configuration.
- ADVANCED** Use this menu to enable and make changes to the advanced features.
- POWER** Use this menu to configure and enable Power Management features.
- BOOT** Use this menu to configure the default system device used to locate and load the Operating System.
- EXIT** Use this menu to exit the current menu or to exit the Setup program.

To access the menu bar items, press the right or left arrow key on the keyboard until the desired item is highlighted.

4.2.2 Legend bar

At the bottom of the Setup screen is a legend bar. The keys in the legend bar allow you to navigate through the various setup menus. The following table lists the keys found in the legend bar with their corresponding functions.

Navigation Key(s)	Function Description
<F1> or <Alt + H>	Displays the General Help screen from anywhere in the BIOS Setup
<Esc>	Jumps to the Exit menu or returns to the main menu from a sub-menu
Left or Right arrow	Selects the menu item to the left or right
Up or Down arrow	Moves the highlight up or down between fields
- (minus key)	Scrolls backward through the values for the highlighted field
+ (plus key) or spacebar	Scrolls forward through the values for the highlighted field
<Enter>	Brings up a selection menu for the highlighted field
<Home> or <PgUp>	Moves the cursor to the first field
<End> or <PgDn>	Moves the cursor to the last field
<F5>	Resets the current screen to its Setup Defaults
<F10>	Saves changes and exits Setup

General help

In addition to the Item Specific Help window, the BIOS setup program also provides a General Help screen. You may launch this screen from any menu by simply pressing <F1> or the <Alt> + <H> combination. The General Help screen lists the legend keys and their corresponding functions.

Saving changes and exiting the Setup program

See “4.7 Exit Menu” for detailed information on saving changes and exiting the setup program.

Scroll bar

When a scroll bar appears to the right of a help window, it indicates that there is more information to be displayed that will not fit in the window. Use <PgUp> and <PgDn> or the up and down arrow keys to scroll through the entire help document. Press <Home> to display the first page, press <End> to go to the last page. To exit the help window, press <Enter> or <Esc>.

Sub-menu

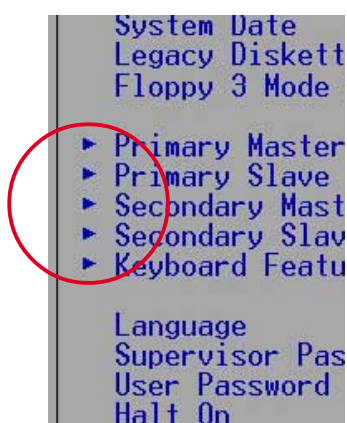

Note that a right pointer symbol (as shown on the left) appears to the left of certain fields. This pointer indicates that you can display a sub-menu from this field. A sub-menu contains additional options for a field parameter. To display a sub-menu, move the highlight to the field and press <Enter>. The sub-menu appears. Use the legend keys to enter values and move from field to field within a sub-menu as you would within a menu. Use the <Esc> key to return to the main menu.

Take some time to familiarize yourself with the legend keys and their corresponding functions. Practice navigating through the various menus and sub-menus. If you accidentally make unwanted changes to any of the fields, use the set default hot key <F5> to load the Setup default values. While moving around through the Setup program, note that explanations appear in the Item Specific Help window located to the right of each menu. This window displays the help text for the currently highlighted field.

4.3 Main menu

When you enter the Setup program, the following screen appears.

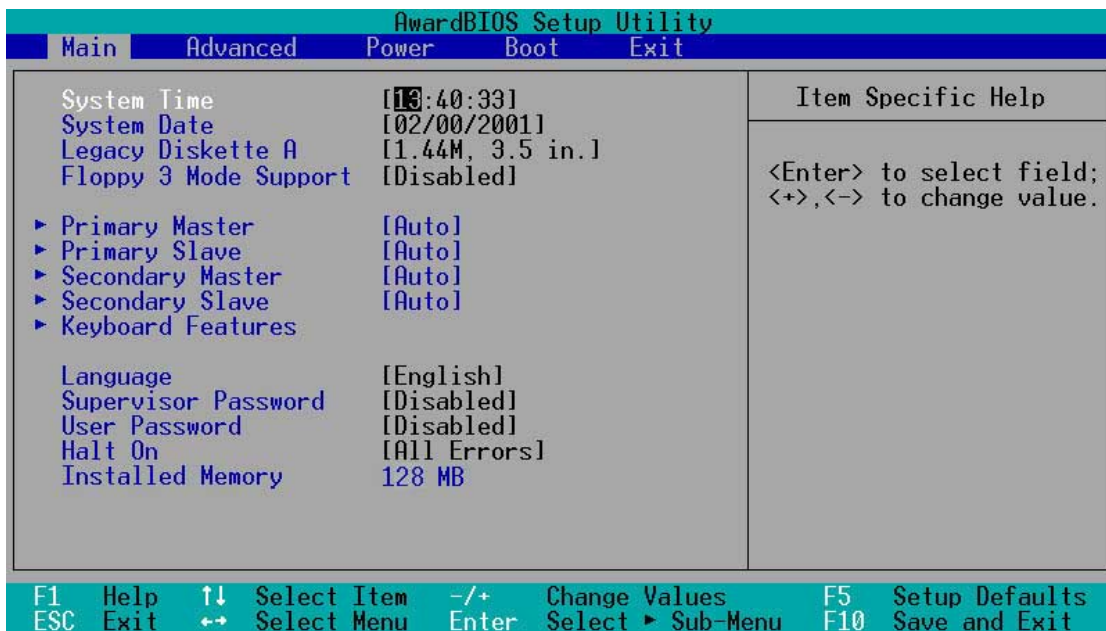

System Time [XX:XX:XX]

Sets the system to the time that you specify (usually the current time). The format is hour, minute, second. Valid values for hour, minute and second are Hour: (00 to 23), Minute: (00 to 59), Second: (00 to 59). Use the <Tab> or <Shift> + <Tab> keys to move between the hour, minute, and second fields.

System Date [XX/XX/XXXX]

Sets the system to the date that you specify (usually the current date). The format is month, day, year. Valid values for month, day, and year are Month: (1 to 12), Day: (1 to 31), Year: (up to 2084). Use the <Tab> or <Shift> + <Tab> keys to move between the month, day, and year fields.

Legacy Diskette A [1.44M, 3.5 in.]

Sets the type of floppy drive installed. Configuration options: [None] [360K, 5.25 in.] [1.2M , 5.25 in.] [720K , 3.5 in.] [1.44M, 3.5 in.] [2.88M, 3.5 in.]

Floppy 3 Mode Support [Disabled]

This is required to support older Japanese floppy drives. The Floppy 3 Mode feature allows reading and writing of 1.2MB (as opposed to 1.44MB) on a 3.5-inch diskette. Configuration options: [Disabled] [Enabled]

4.3.1 Primary & Secondary Master/Slave

AwardBIOS Setup Utility	
Main	
Primary Master [Auto]	Item Specific Help
Type [Auto]	<Enter> to select the type of the IDE drive. [User Type HDD] allows you to set each entry on your own. WARNING: Ultra DMA mode 3/4/5 can be enabled only when BIOS detects shielded 80-pin cable.
Cylinders [1024]	
Head [255]	
Sector [63]	
CHS Capacity 8422MB	
Maximum LBA Capacity 25590MB	
Multi-Sector Transfers [Maximum]	
SMART Monitoring [Disabled]	
PIO Mode [4]	
ULTRA DMA Mode [Disabled]	
F1 Help ↑↓ Select Item -/+ Change Values F5 Setup Defaults ESC Exit ↔ Select Menu Enter Select ► Sub-Menu F10 Save and Exit	

Type [Auto]

Select [Auto] to automatically detect an IDE hard disk drive. If automatic detection is successful, Setup automatically fills in the correct values for the remaining fields on this sub-menu. If automatic detection fails, this may be because the hard disk drive is too old or too new. If the hard disk was already formatted on an older system, Setup may detect incorrect parameters. In these cases, select [User Type HDD] to manually enter the IDE hard disk drive parameters. Refer to the next section for details.



Before attempting to configure a hard disk drive, make sure you have the correct configuration information supplied by the drive manufacturer. Incorrect settings may cause the system to fail to recognize the installed hard disk.

[User Type HDD]

AwardBIOS Setup Utility		
Main		
Primary Master [User Type HDD]	Item Specific Help	
Type [User Type HDD]	<p><Enter> to select the type of the IDE drive. [User Type HDD] allows you to set each entry on your own.</p> <p>WARNING: Ultra DMA mode 3/4/5 can be enabled only when BIOS detects shielded 80-pin cable.</p>	
Translation Method [LBA]		
Cylinders [1024]		
Head [255]		
Sector [63]		
CHS Capacity 8422MB		
Maximum LBA Capacity 25590MB		
Multi-Sector Transfers [Maximum]		
SMART Monitoring [Disabled]		
PID Mode [4]		
ULTRA DMA Mode [Disabled]		
F1 Help ↑↓ Select Item -/+ Change Values F5 Setup Defaults		
ESC Exit ↔ Select Menu Enter Select ► Sub-Menu F10 Save and Exit		

Manually enter the number of cylinders, heads and sectors per track for the drive. Refer to the drive documentation or on the drive label for this information.



After entering the IDE hard disk drive information into BIOS, use a disk utility, such as FDISK, to partition and format new IDE hard disk drives. This is necessary so that you can write or read data from the hard disk. Make sure to set the partition of the Primary IDE hard disk drives to active.

If no drive is installed or if you are removing a drive and not replacing it, select [None].

Other options for the Type field are:

[CD-ROM] - for IDE CD-ROM drives

[LS-120] - for LS-120 compatible floppy disk drives

[ZIP] - for ZIP-compatible disk drives

[MO] - for IDE magneto optical disk drives

[Other ATAPI Device] - for IDE devices not listed here

After making your selections on this sub-menu, press the <Esc> key to return to the Main menu. When the Main menu appears, the hard disk drive field displays the size for the hard disk drive that you configured.

Translation Method [LBA]

Select the hard disk drive type in this field. When Logical Block Addressing (LBA) is enabled, the 28-bit addressing of the hard drive is used without regard for cylinders, heads, or sectors. Note that LBA Mode is necessary for drives with more than 504MB storage capacity. Configuration options: [LBA] [LARGE] [Normal] [Match Partition Table] [Manual]

Cylinders

This field configures the number of cylinders. Refer to the drive documentation to determine the correct value. To make changes to this field, set the Type field to [User Type HDD] and the Translation Method field to [Manual].

Head

This field configures the number of read/write heads. Refer to the drive documentation to determine the correct value. To make changes to this field, set the Type field to [User Type HDD] and the Translation Method field to [Manual].

Sector

This field configures the number of sectors per track. Refer to the drive documentation to determine the correct value. To make changes to this field, set the Type field to [User Type HDD] and the Translation Method field to [Manual].

CHS Capacity

This field shows the drive's maximum CHS capacity as calculated by the BIOS based on the drive information you entered.

Maximum LBA Capacity

This field shows the drive's maximum LBA capacity as calculated by the BIOS based on the drive information you entered.

Multi-Sector Transfers [Maximum]

This option automatically sets the number of sectors per block to the highest number that the drive supports. Note that when this field is automatically configured, the set value may not always be the fastest value for the drive. You may also manually configure this field. Refer to the documentation that came with the hard drive to determine the optimum value and set it manually. To make changes to this field, set the Type field to [User Type HDD]. Configuration options: [Disabled] [2 Sectors] [4 Sectors] [8 Sectors] [16 Sectors] [32 Sectors] [Maximum]

SMART Monitoring [Disabled]

This field allows you to enable or disable the S.M.A.R.T. (Self-Monitoring, Analysis and Reporting Technology) system that utilizes internal hard disk drive monitoring technology. This parameter is normally disabled because the resources used in the SMART monitoring feature may decrease system performance. Configuration options: [Disabled] [Enabled]

PIO Mode [4]

This option lets you set a PIO (Programmed Input/Output) mode for the IDE device. Modes 0 through 4 provide successive increase in performance. Configuration options: [0] [1] [2] [3] [4]

Ultra DMA Mode [Disabled]

Ultra DMA capability allows improved transfer speeds and data integrity for compatible IDE devices. Set to [Disabled] to suppress Ultra DMA capability. To make changes to this field, set the Type field to [User Type HDD]. Configuration options: [0] [1] [2] [3] [4] [5] [6] [Disabled]

4.3.2 Keyboard Features

AwardBIOS Setup Utility	
Main	
Keyboard Features	Item Specific Help
Boot Up NumLock Status [On] Keyboard Auto-Repeat Rate [6/Sec] Keyboard Auto-Repeat Delay [1/4 Sec]	Select Power-on state for Numlock

F1 Help ↑↓ Select Item -/+ Change Values F5 Setup Defaults
ESC Exit ↔ Select Menu Enter Select ► Sub-Menu F10 Save and Exit

Boot Up NumLock Status [On]

This field enables users to activate the Number Lock function upon system boot. Configuration options: [Off] [On]

Keyboard Auto-Repeat Rate [6/Sec]

This controls the speed at which the system registers repeated keystrokes. Options range from 6 to 30 characters per second. Configuration options: [6/Sec] [8/Sec] [10/Sec] [12/Sec] [15/Sec] [20/Sec] [24/Sec] [30/Sec]

Keyboard Auto-Repeat Delay [1/4 Sec]

This field sets the time interval for displaying the first and second characters. Configuration options: [1/4 Sec] [1/2 Sec] [3/4 Sec] [1 Sec]

Main menu items continued...

Language [English]

This field displays the BIOS language version.

Supervisor Password [Disabled] / User Password [Disabled]

These fields allow you to set passwords. To set a password, highlight the appropriate field and press <Enter>. Type in a password then press <Enter>. You can type up to eight alphanumeric characters. Symbols and other characters are ignored. To confirm the password, type the password again and press <Enter>. The password is now set to [Enabled]. This password allows full access to the BIOS Setup menus. To clear the password, highlight this field and press <Enter>. The same dialog box as above appears. Press <Enter>. The password is set to [Disabled].

A note about passwords

The BIOS Setup program allows you to specify passwords in the Main menu. The passwords control access to the BIOS during system startup. Passwords are not case sensitive, meaning, passwords typed in either uppercase or lowercase letters are accepted. The BIOS Setup program allows you to specify two different passwords: a Supervisor password and a User password. If you did not set a Supervisor password, anyone can access the BIOS Setup program. If you did, the Supervisor password is required to enter the BIOS Setup program and to gain full access to the configuration fields.

Halt On [All Errors]

This field specifies the types of errors that will cause the system to halt. Configuration options: [All Errors] [No Error] [All but Keyboard] [All but Disk] [All but Disk/Keyboard]

Installed Memory [XXX MB]

This field automatically displays the amount of conventional memory detected by the system during the boot process.

4.4 Advanced Menu

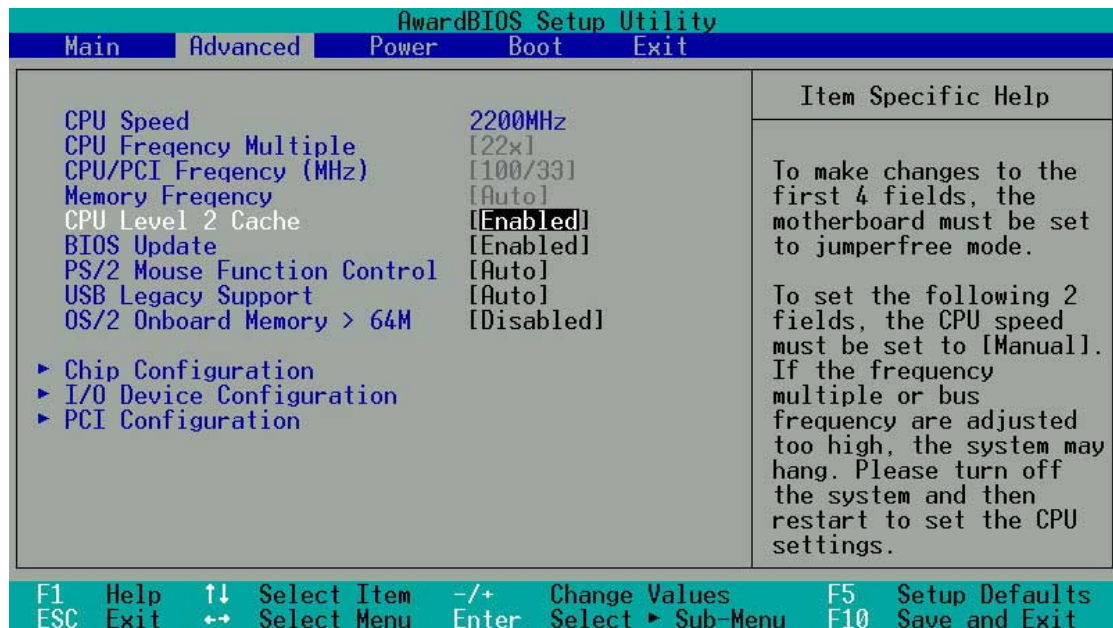

CPU Speed [Manual]

This field displays the internal frequency of the CPU.

CPU Frequency Multiple (when CPU Speed is set to [Manual])

This field displays the frequency multiple between the CPU's internal frequency (CPU speed) and external frequency.

CPU/PCI Frequency (MHz) (when CPU Speed is set to [Manual])

The setting displayed in this field depends on the CPU Frequency Multiple. This feature tells the clock generator which frequency to send to the system bus and PCI bus. The bus frequency (external frequency) multiplied by the bus multiple equals the CPU speed.

Memory Frequency [Auto]

This field is defaulted to function automatically, and determines whether the memory clock frequency is set to be in synchronous or asynchronous mode with respect to the system frequency.

CPU Level 2 Cache [Enabled]

This field is defaulted to [Enabled]. Select [Disabled] to turn off the CPU Level 2 built-in cache. Configuration options: [Disabled] [Enabled]

BIOS Update [Enabled]

This field functions as an update loader integrated into the BIOS to supply the processor with the required data. When set to [Enabled], the BIOS loads the update on all processors during system bootup. Configuration options: [Disabled] [Enabled]

PS/2 Mouse Function Control [Auto]

The default setting [Auto] permits the system to detect a PS/2 mouse at startup. If a mouse is detected, the BIOS assigns IRQ12 to the PS/2 mouse. Otherwise, IRQ12 can be used for expansion cards. When you set this field to [Enabled], BIOS reserves IRQ12, whether or not a PS/2 mouse is detected at startup. Configuration options: [Enabled] [Auto]

USB Legacy Support [Auto]

This motherboard supports Universal Serial Bus (USB) devices. The default of [Auto] permits the system to detect a USB device at startup. If detected, the USB controller legacy mode is enabled. If not detected, the USB controller legacy mode is disabled. When you set this field to [Disabled], the USB controller legacy mode is disabled whether or not you are using a USB device. Configuration options: [Disabled] [Enabled] [Auto]

OS/2 Onboard Memory > 64M [Disabled]

When using OS/2 operating systems with installed DRAM of greater than 64MB, you need to set this option to [Enabled]. Otherwise, leave to the default setting [Disabled]. Configuration options: [Disabled] [Enabled]

4.4.1 Chip Configuration

AwardBIOS Setup Utility		
Advanced		
Chip Configuration		Item Specific Help
SDRAM Configuration	[By SPD]	<Enter> to select SDRAM configuration. [By SPD] is recommended. [User Define] allows you to set each configuration on your own.
SDRAM CAS Latency	[2.5T]	
SDRAM RAS to CAS Delay	[3T]	
SDRAM RAS Precharge Time	[3T]	
SDRAM RAS Active Time	[6T]	
SDRAM Command Lead-off Time	[Auto]	
Graphics Aperture Size	[64MB]	
AGP Capability	[4X Mode]	
AGP Fast Write Capability	[Disabled]	
Onboard VGA Shared Memory Size	[32M]	
Video Memory Cache Mode	[UC]	
Memory Hole At 15M-16M	[Disabled]	
PCI 2.1 Support	[Enabled]	
Onboard PCI IDE Enable	[Both]	
IDE Bus Master Support	[Enabled]	
F1 Help	↑↓ Select Item	-/+ Change Values
ESC Exit	↔ Select Menu	Enter Select ▶ Sub-Menu
		F5 Setup Defaults
		F10 Save and Exit

SDRAM Configuration [By SPD]

This parameter allows you to set the optimal timings for items 2–5, depending on the memory modules that you are using. The default setting is [By SPD], which configures items 2–5 by reading the contents in the SPD (Serial Presence Detect) device. The EEPROM on the memory module stores critical information about the module, such as memory type, size, speed, voltage interface, and module banks.

Configuration options: [User Defined] [By SPD]



NOTE! The following 4 SDRAM parameters appear only when you set the SDRAM Configuration to [User Defined].

SDRAM CAS Latency [2.5T]

This item controls the latency between the SDRAM read command and the time the data actually becomes available.

SDRAM RAS to CAS Delay [3T]

This item controls the latency between the SDRAM active command and the read/write command.

SDRAM RAS Precharge Time [3T]

This item controls the idle clocks after issuing a precharge command to the SDRAM.

SDRAM RAS Active Time [6T]

This item controls the number of SDRAM clocks used for SDRAM parameters.

SDRAM Command Lead-off Time [Auto]

When set to [2T], memore read/write commands are issued 1 clock cycle behind the memory address (MA). When set to [1T], read/write commands and MA are issued simultaneously. Configuration options: [2T] [1T] [Auto]

Graphics Aperture Size [64MB]

This feature sets the size of mapped memory for AGP graphic data. Configuration options: [4MB] [8MB] [16MB] [32MB] [64MB] [128MB] [256MB]

Onboard VGA Shared Memory Size [32M]

This feature sets the size of shared memory for VGA graphic data. Configuration options: [4MB] [8MB] [16MB] [32MB] [64MB]

AGP Capability [4X Mode]

This motherboard supports the AGP 4X interface that transfers video data at 1066MB/s. AGP 4X is backward-compatible, so you may keep the default [4X Mode] even if you are using an AGP 1X or 2X video card. When set to [1X Mode], the AGP interface only provides a peak data throughput of 266MB/s even if you are using an AGP 2X/4X card. When set to [2X Mode], the AGP interface provides a peak data trthroughput of only 533MB/s even if you are using an AGP 4X card. Configuration options: [1X Mode] [2X Mode] [4X Mode]

AGP Fast Write Capability [Disabled]

Configuration options: [Disabled] [Enabled]

Video Memory Cache Mode [UC]

USWC (uncacheable, speculative write combining) is a new cache technology for the video memory of the processor. It can greatly improve the display speed by caching the display data. You must set this to UC (uncacheable) if your display card does not support this feature, otherwise the system may not boot. Configuration options: [UC] [USWC]

Memory Hole At 15M-16M [Disabled]

This field allows you to reserve an address space for ISA expansion cards. Setting the address space to a particular setting makes that memory space unavailable to other system components. Expansion cards can only access memory up to 16MB. Configuration options: [Disabled] [Enabled]

PCI 2.1 Support [Enabled]

This field allows you to enable or disable the PCI 2.1 features. Keep the default setting [Enabled] if you installed PCI 2.1 compliant cards. Set to [Disabled] if you installed any card that is not PCI 2.1 compliant.

Configuration options: [Disabled] [Enabled]

Onboard PCI IDE Enable [Both]

This field allows you to enable either the primary IDE channel or secondary IDE channel, or both. You can also set both channels to [Disabled].

Configuration options: [Both] [Primary] [Secondary] [Disabled].

IDE Bus Master Support [Enable]

This field enables or disables the IDE Bus Master Capability under the DOS environment. Configuration options: [Enabled] [Disabled]

4.4.2 I/O Device Configuration

AwardBIOS Setup Utility	
Advanced	
I/O Device Configuration	Item Specific Help
Floppy Disk Access Control [R/W]	<Enter> to select.
Onboard Serial Port 1 [3F8H/IRQ4]	
Onboard Serial Port 2 [2F8H/IRQ3]	
UART2 Use As [COM Port]	
Onboard Parallel Port [378H/IRQ7]	
Parallel Port Mode [ECP+EPP]	
ECP DMA Select [3]	
Onboard Game Port [200H-207H]	
Onboard MIDI I/O [Disabled]	

F1 Help ↑↓ Select Item -/+ Change Values F5 Setup Defaults
ESC Exit ↔ Select Menu Enter Select ► Sub-Menu F10 Save and Exit

Floppy Disk Access Control [R/W]

When set to [Read Only], this parameter protects files from being copied to floppy disks by allowing reads from, but not writes to, the floppy disk drive. The default setting [R/W] allows both reads and writes. Configuration options: [R/W] [Read Only]

Onboard Serial Port 1 [3F8H/IRQ4]

Onboard Serial Port 2 [Disabled]

These fields allow you to set the addresses for the onboard serial connectors. Serial Port 1 and Serial Port 2 must have different addresses. Configuration options: [3F8H/IRQ4] [2F8H/IRQ3] [3E8H/IRQ4] [2E8H/IRQ10] [Disabled]

UART2 Use As [Disabled]

This field allows you to select the device on which to assign UART2. If you select [IR] or [Smart Card Reader], set an I/O address for the item **Onboard Serial Port 2**. Configuration options: [COM Port] [IR] [Smart Card Reader]

Onboard Parallel Port [378H/IRQ7]

This field sets the address of the onboard parallel port connector. If you disable this field, the Parallel Port Mode and ECP DMA Select configurations are not available. Configuration options: [Disabled] [378H/IRQ7] [278H/IRQ5]

Parallel Port Mode [ECP+EPP]

This field allows you to set the operation mode of the parallel port. [Normal] allows normal-speed operation but in one direction only; [EPP] allows bidirectional parallel port operation; [ECP] allows the parallel port to operate in bidirectional DMA mode; [ECP+EPP] allows normal speed operation in a two-way mode. Configuration options: [Normal] [EPP] [ECP] [ECP+EPP]

ECP DMA Select [3]

This field allows you to configure the parallel port DMA channel for the selected ECP mode. This selection is available only if you select [ECP] or [ECP+EPP] in Parallel Port Mode above. Configuration options: [1] [3]

Onboard Game Port [200H-207H]

This field sets the I/O address to the game port. Configuration options: [200H-207H] [208H-20FH] [Disabled]

Onboard MIDI [Disabled]

This field sets the I/O address for MIDI. Configuration options: [330H-331H] [300H-301H] [Disabled]

4.4.3 PCI Configuration

AwardBIOS Setup Utility	
Advanced	
PCI Configuration	Item Specific Help
Slot 1 IRQ [Auto]	<Enter> to select an IRQ.
Slot 2 IRQ [Auto]	
Slot 3 IRQ [Auto]	
PCI/VGA Palette Snoop [Disabled]	
PCI Latency Timer [32]	
Primary VGA BIOS [PCI VGA Card]	
USB Function [Enabled]	
USB 2.0 Function [Enabled]	
Onboard LAN Boot ROM [Disabled]	
▶ Onboard PCI Devices Control	
▶ PCI IRQ Resource Exclusion	

F1 Help ↑↓ Select Item -/+ Change Values F5 Setup Defaults
ESC Exit ↔ Select Menu Enter Select ▶ Sub-Menu F10 Save and Exit

Slot 1, 2, 3 IRQ [Auto]

These fields automatically assign the IRQ for each PCI slot. The default setting for each field is [Auto], which utilizes auto-routing to determine IRQ assignments. Configuration options: [Auto] [NA] [3] [4] [5] [7] [9] [10] [11] [12] [14] [15]

PCI/VGA Palette Snoop [Disabled]

Some non-standard VGA cards, like graphics accelerators or MPEG video cards, may not show colors properly. Setting this field to [Enabled] corrects this problem. If you are using standard VGA cards, leave this field to the default setting [Disabled]. Configuration options: [Disabled] [Enabled]

PCI Latency Timer [32]

Leave this field to the default setting [32] for best performance and stability.

Primary VGA BIOS [PCI VGA Card]

This field allows you to select the primary graphics card. Configuration options: [PCI VGA Card] [AGP VGA Card]

Onboard VGA [Enabled]

The onboard VGA is enabled by default. Configuration options: [Enabled] [Disabled]

USB Function [Enabled]

This motherboard supports Universal Serial Bus (USB) devices. Keep the default setting [Enabled] if you connect USB devices. Select the setting [Disabled] if you do not wish to use the USB feature. Configuration options: [Disabled] [Enabled]

USB 2.0 Function [Enabled]

This motherboard supports Universal Serial Bus 2.0 (USB) devices. Keep the default setting [Enabled] if you connect USB 2.0 devices. Select the setting [Disabled] if you do not wish to use the USB 2.0 feature. Configuration options: [Disabled] [Enabled]

Onboard LAN Boot Rom [Disabled]

This motherboard supports boot up from onboard LAN Boot Rom. Select the [Enabled] to activate this feature. Configuration options: [Disabled] [Enabled]

4.4.3.1 Onboard PCI Devices Control

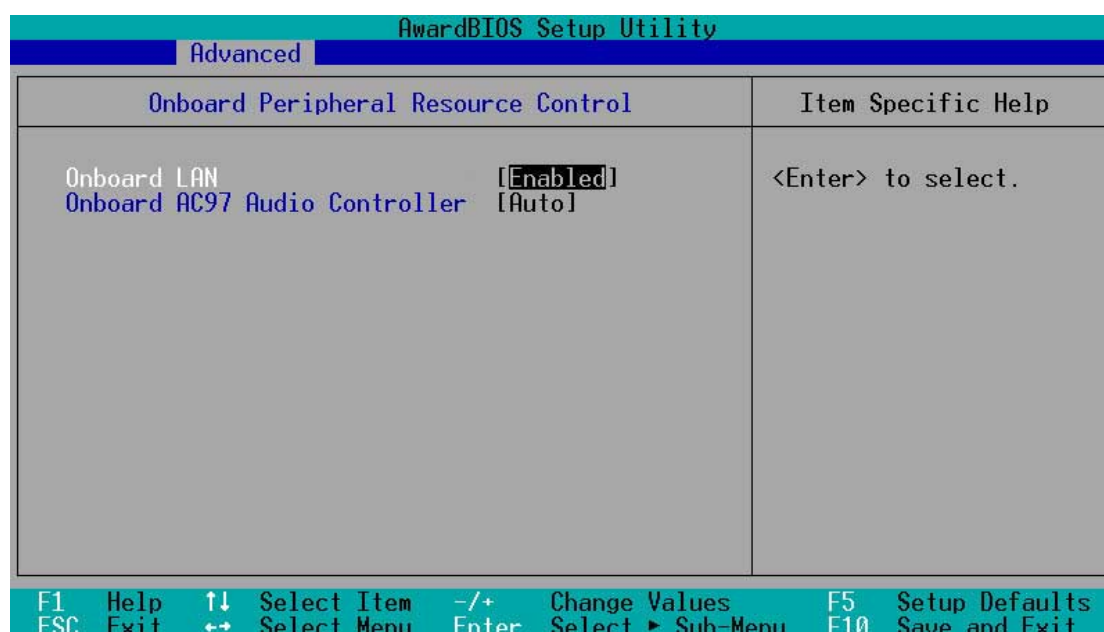

Onboard LAN [Enabled]

[Auto] allows the BIOS to detect whether you are using any audio device. If an audio device is detected, the onboard audio controller is enabled; if no audio device is detected, the controller is disabled. If there are conflicts with the onboard modem/audio controller, set the appropriate field to [Disabled]. Configuration options: [Disabled] [Enabled]

Onboard AC97 Audio Controller [Auto]

[Auto] allows the BIOS to detect whether you are using any modem/audio device. If a modem/audio device is detected, the onboard modem/audio controller is enabled; if no modem/audio device is detected, the controller is disabled. If there are conflicts with the onboard modem/audio controller, set the appropriate field to [Disabled]. Configuration options: [Disabled] [Auto]

4.4.3.2 PCI IRQ Resource Exclusion

AwardBIOS Setup Utility			
Advanced			
PCI IRQ Resource Exclusion			Item Specific Help
IRQ 3	Reserved	[No/ICU]	Select [Yes] if this IRQ is required by a legacy ISA card and you are not using ICU; otherwise, select [No/ICU].
IRQ 4	Reserved	[No/ICU]	
IRQ 5	Reserved	[No/ICU]	
IRQ 7	Reserved	[No/ICU]	
IRQ 9	Reserved	[No/ICU]	
IRQ 10	Reserved	[No/ICU]	
IRQ 11	Reserved	[No/ICU]	
IRQ 12	Reserved	[No/ICU]	
IRQ 14	Reserved	[No/ICU]	
IRQ 15	Reserved	[No/ICU]	

F1 Help ↑↓ Select Item -/+ Change Values F5 Setup Defaults
ESC Exit ↔ Select Menu Enter Select ► Sub-Menu F10 Save and Exit

IRQ XX Reserved [No/ICU]

These fields indicate whether or not the displayed IRQ for each field is being used by a legacy (non-PnP) ISA card. The setting [No/ICU] for an IRQ field indicates that you are using the ISA Configuration Utility (ICU), and that this particular IRQ is NOT required by a legacy ISA card. Set the IRQ field to [Yes] if you install a legacy ISA card that requires a unique IRQ and you are NOT using ICU. Configuration options: [No/ICU] [Yes]

4.5 Power Menu

The Power menu allows you to reduce power consumption. This feature turns off the video display and shuts down the hard disk after a period of inactivity.

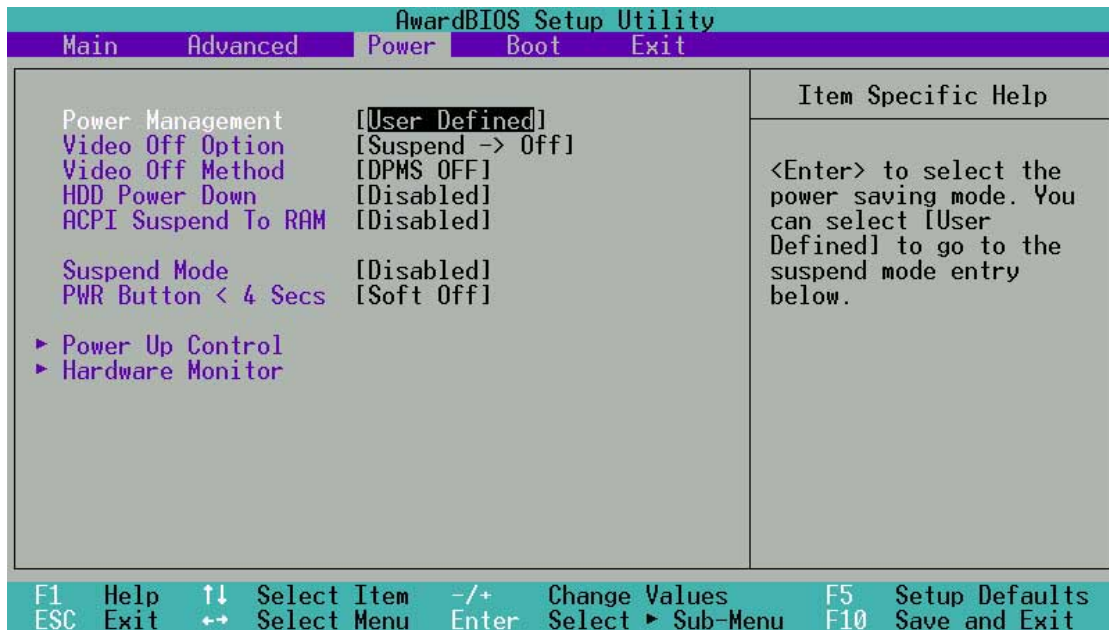

Power Management [User Defined]

This field allows you to activate or deactivate the automatic power saving features. When set to [Disabled], the power management features do not function regardless of the other settings on this menu. The [User Defined] option allows you to set the period of inactivity before the system enters suspend mode. Refer to "Suspend Mode" later in this section.

When set to [Max Saving], system power is conserved to its greatest amount. This setting automatically puts the system into suspend mode after a brief period of system inactivity. [Min Saving] allows the least power saving as the system enters suspend mode only after a long period of inactivity. Configuration options: [User Defined] [Disabled] [Min Saving] [Max Saving]



You should install the Advanced Power Management (APM) utility to keep the system time updated even when the computer enters suspend mode. In Windows 3.x and Windows 95, you need to install Windows with the APM feature. In Windows 98 or later, APM is automatically installed as indicated by a battery and power cord icon labeled "Power Management" in the Control Panel. Select the item "Advanced" in the Power Management Properties dialog box.

Video Off Option [Suspend -> Off]

This field determines when to activate the video off feature for monitor power management. Configuration options: [Always On] [Suspend -> Off]

Video Off Method [DPMS OFF]

This field defines the video off features. The Display Power Management System (DPMS) feature allows the BIOS to control the video display card if it supports the DPMS feature. [Blank Screen] only blanks the screen. Use this for monitors without power management or “green” features.



Even if installed, your screen saver does not display when you select [Blank Screen] for the above field.

[V/H SYNC+Blank] blanks the screen and turns off vertical and horizontal scanning. Configuration options: [Blank Screen] [V/H SYNC+Blank] [DPMS Standby] [DPMS Suspend] [DPMS OFF] [DPMS Reduce ON]

HDD Power Down [Disabled]

Shuts down any IDE hard disk drives in the system after a period of inactivity as set in this user-configurable field. This feature does not affect SCSI hard drives. Configuration options: [Disabled] [1 Min] [2 Min] [3 Min]...[15 Min]

ACPI Suspend To RAM [Disabled]

This field allows you to enable or disable the ACPI Suspend-to-RAM feature. To support this feature, the +5VSB of the power supply should have the capacity to provide more than 720mA current. Configuration options: [Disabled] [Enabled]

Suspend Mode [Disabled]

Sets the time period before the system goes into suspend mode. Configuration options: [Disabled] [1~2 Min] [2~3 Min] [4~5 min] [8~9 Min] [20 Min] [30 Min]

PWR Button < 4 Secs [Soft Off]

When set to [Soft off], the ATX switch can be used as a normal system power-off button when pressed for less than 4 seconds. [Suspend] allows the button to have a dual function where pressing less than 4 seconds puts the system in sleep mode. Regardless of the setting, holding the ATX switch for more than 4 seconds powers off the system. Configuration options: [Soft off] [Suspend]

4.5.1 Power Up Control

AwardBIOS Setup Utility	
Power	
Power Up Control	Item Specific Help
AC Power Loss Restart [Disabled]	<Enter> to select whether or not to restart the system after AC power loss.
Wake/Power Up On Ext. Modem [Disabled]	
Power Up On PCI Card [Disabled]	
Wake On Lan [Disabled]	
Power On By PS/2 Keyboard [Disabled]	
Automatic Power Up [Disabled]	

F1 Help ↑↓ Select Item -/+ Change Values F5 Setup Defaults
ESC Exit ↔ Select Menu Enter Select ► Sub-Menu F10 Save and Exit

AC PWR Loss Restart [Disabled]

This allows you to set whether or not to reboot the system after power interruptions. [Disabled] leaves your system off while [Enabled] reboots the system. [Previous State] sets the system back to the state it was before the power interruption. Configuration options: [Disabled] [Enabled] [Previous State]

Wake/Power Up On Ext. Modem [Disabled]

This allows either settings of [Enabled] or [Disabled] for powering up the computer when the external modem receives a call while the computer is in Soft-off mode. Configuration options: [Disabled] [Enabled]



The computer cannot receive or transmit data until the computer and applications are fully running. Thus, connection cannot be made on the first try. Turning an external modem off and then back on while the computer is off causes an initialization string that turns the system power on.

Power Up On PCI Card [Disabled]

When set to [Enabled], this parameter allows you to turn on the system through a PCI modem. This feature requires an ATX power supply that provides at least 1A on the +5VSB lead. Configuration options: [Disabled] [Enabled]

Wake On LAN [Disabled]

When set to [Enabled], this item allows you to turn on the system through the onboard LAN. This feature requires an ATX power supply that provides at least 1A on the +5VSB lead. Configuration options: [Disabled] [Enabled]

Power On By PS/2 Keyboard [Disabled]

This parameter allows you to use specific keys on the keyboard to turn on the system. This feature requires an ATX power supply that provides at least 1A on the +5VSB lead. Configuration options: [Disabled] [Space Bar] [Ctrl-Esc] [Power Key]

Automatic Power Up [Disabled]

This allows an unattended or automatic system power up. You may configure your system to power up at a certain time of the day by selecting [Everyday] or at a certain time and day by selecting [By Date]. Configuration options: [Disabled] [Everyday] [By Date]

4.5.2 Hardware Monitor

AwardBIOS Setup Utility	
Power	
Hardware Monitor	Item Specific Help
MB Temperature	33°C/91°F
CPU Temperature	61°C/141°F
CPU Fan Speed	7500RPM
Chassis Fan Speed	N/A
VCORE Voltage	1.52V
+3.3V Voltage	3.33V
+5V Voltage	5.00V
+12V Voltage	12.00V

F1 Help ↑↓ Select Item -/+ Change Values F5 Setup Defaults
ESC Exit ↔ Select Menu Enter Select ► Sub-Menu F10 Save and Exit

MB Temperature [xxxC/xxxF]

CPU Temperature [xxxC/xxxF]

The onboard hardware monitor automatically detects the MB (motherboard) and CPU temperatures.

CPU Fan Speed [xxxxRPM] or N/A

Chassis Fan Speed [xxxxRPM] or N/A

The onboard hardware monitor automatically detects the CPU and chassis fan speeds and displays the fan speeds in revolutions per minute (RPM). If any of the fans is not connected to the fan connectors on the motherboard, the specific field will show N/A.

VCORE Voltage, +3.3V Voltage, +5V Voltage, +12V Voltage

The onboard hardware monitor automatically detects the voltage output through the onboard voltage regulators and show the values on these fields.

4.6 Boot Menu

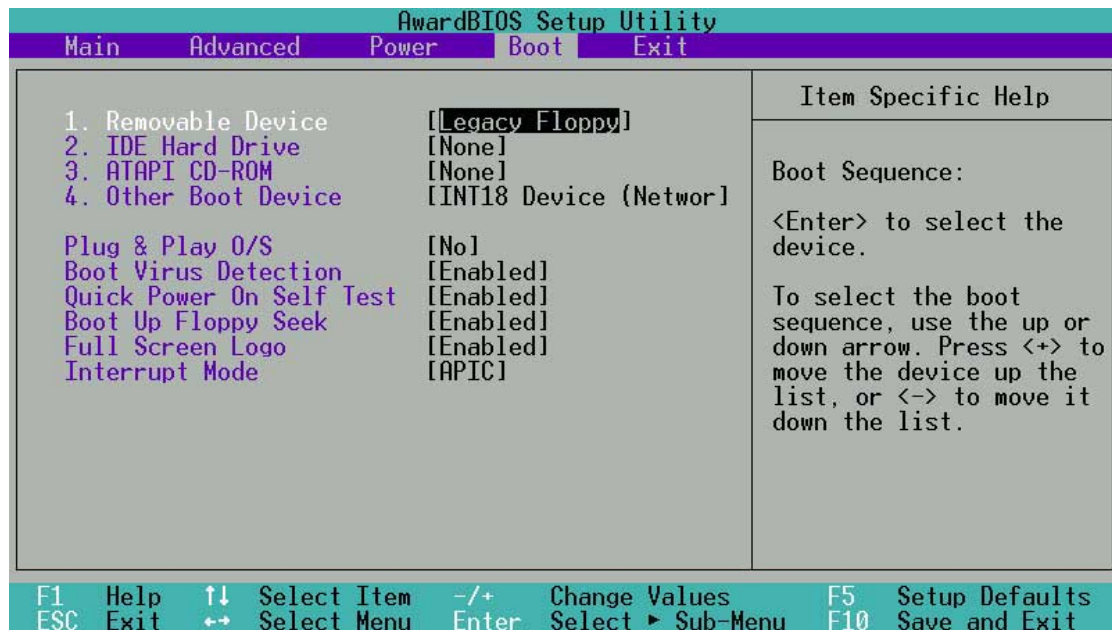

Boot Sequence

The Boot menu allows you to select among the four possible types of boot devices listed using the up and down arrow keys. By using the <+> or <Space> key, you can promote devices and by using the <-> key, you can demote devices. Promotion or demotion of devices alters the priority which the system uses to search for a boot device on system power up. Configuration fields include Removable Devices, IDE Hard Drive, ATAPI CD-ROM, and Other Boot Device.

Removable Device [Legacy Floppy]

Configuration options: [Disabled] [Legacy Floppy] [LS-120] [ZIP] [ATAPIMO]

IDE Hard Drive

This field allows you to select which IDE hard disk drive to use in the boot sequence. Pressing [Enter] will show the product IDs of all connected IDE hard disk drives.

ATAPI CD-ROM

This field allows you to select which ATAPI CD-ROM drive to use in the boot sequence. Pressing [Enter] will show the product IDs of all your connected ATAPI CD-ROM drives.

Other Boot Device Select [INT18 Device (Network)]

Configuration options: [Disabled] [SCSI Boot Device] [INT18 Device (Network)]

Plug & Play O/S [No]

This field allows you to use a Plug-and-Play (PnP) operating system to configure the PCI bus slots instead of using the BIOS. When [Yes] is selected, interrupts may be reassigned by the OS. If you installed a non-PnP OS or if you want to prevent reassigning of interrupt settings, keep the default setting [No]. Configuration options: [No] [Yes]

Boot Virus Detection [Enabled]

This field allows you to set boot virus detection, ensuring a virus-free boot sector. The system halts and displays a warning message when it detects a virus. If this occurs, you can either allow the operation to continue or use a virus-free bootable floppy disk to restart and investigate your system. Configuration options: [Disabled] [Enabled]

Quick Power On Self Test [Enabled]

This field speeds up the Power-On-Self Test (POST) routine by skipping retesting a second, third, and fourth time. Configuration options: [Disabled] [Enabled]

Boot Up Floppy Seek [Enabled]

When enabled, the BIOS will seek the floppy disk drive to determine whether the drive has 40 or 80 tracks. Configuration options: [Disabled] [Enabled]

Full Screen Logo [Enabled]

This field enables the display of the full screen logo that appears as the PC boots up. Configuration options: [Disabled] [Enabled]



Make sure that the above item is set to [Enabled] if you wish to use the ASUS MyLogo2™ feature.

Interrupt Mode [APIC]

This item controls the IRQ structure. The new APIC creates a range of IRQs larger than the standard 16 IRQ channels. The standard setting of PIC limits the number of IRQs to the standard IRQ0 to IRQ15. Windows 2000 and XP support APIC settings. Select between new APIC or PIC. Configuration options: [APIC] [PIC]

4.7 Exit Menu

When you have made all of your selections from the various menus in the Setup program, save your changes and exit Setup. Select Exit from the menu bar to display the following menu.

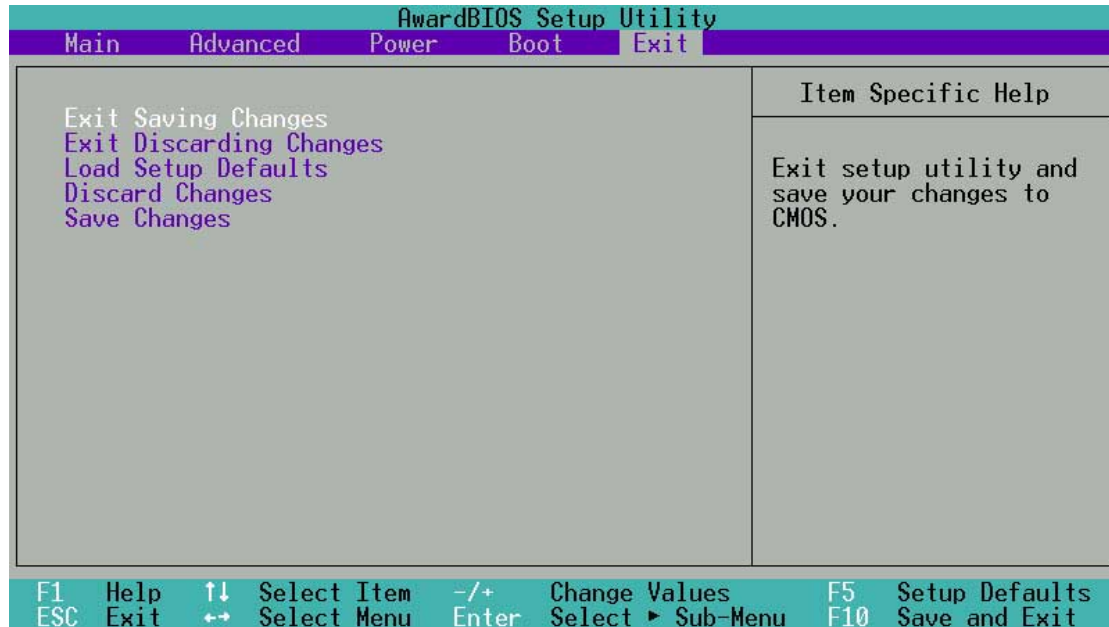

Pressing <Esc> does not immediately exit this menu. Select one of the options from this menu or <F10> from the legend bar to exit.

Exit Saving Changes

Once you are finished making your selections, choose this option from the Exit menu to ensure the values you selected are saved to the CMOS RAM. The CMOS RAM is sustained by an onboard backup battery and stays on even when the PC is turned off. When you select this option, a confirmation window appears. Select [Yes] to save changes and exit.



If you attempt to exit the Setup program without saving your changes, the program prompts you with a message asking if you want to save your changes before exiting. Pressing <Enter> saves the changes while exiting.

Exit Discarding Changes

Select this option only if you do not want to save the changes that you made to the Setup program. If you made changes to fields other than system date, system time, and password, the BIOS asks for a confirmation before exiting.

Load Setup Defaults

This option allows you to load the default values for each of the parameters on the Setup menus. When you select this option or if you press <F5>, a confirmation window appears. Select [Yes] to load default values. Select Exit Saving Changes or make other changes before saving the values to the non-volatile RAM.

Discard Changes

This option allows you to discard the selections you made and restore the previously saved values. After selecting this option, a confirmation appears. Select [Yes] to discard any changes and load the previously saved values.

Save Changes

This option saves your selections without exiting the Setup program. You can then return to other menus and make further changes. After you select this option, a confirmation window appears. Select [Yes] to save any changes to the non-volatile RAM.

Chapter 5

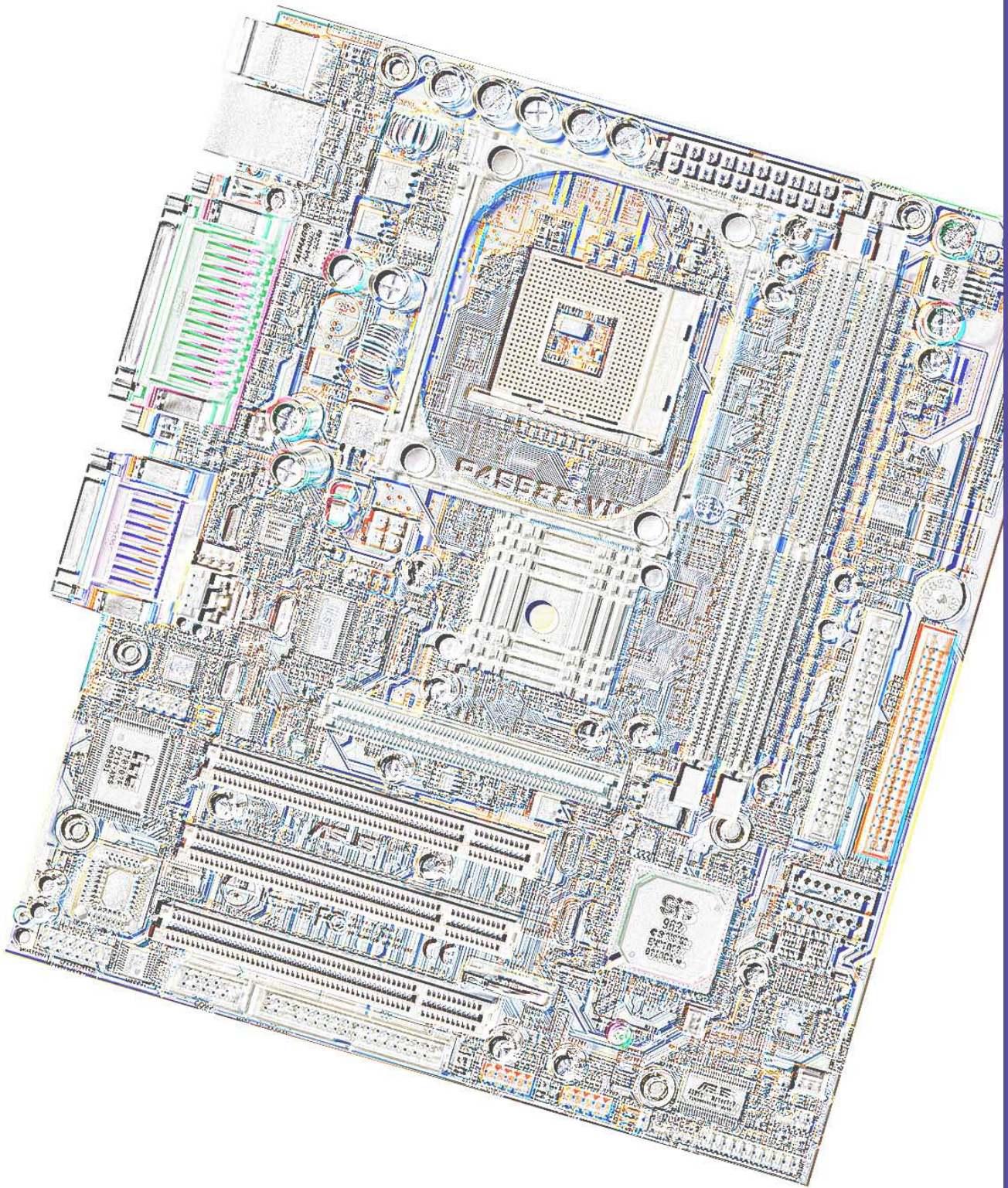

Software support

5.1 Install an operating system

This motherboard supports Windows 98/ME/NT/2000/XP and OS/2 operating system (OS). Always install the latest OS version and corresponding updates so you can maximize the features of your hardware.

5.1.1 Windows first time installation

When you start Windows for the first time after installing the motherboard, Windows detects all Plug-n-Play devices. Follow the **Add New Hardware** wizard to install the necessary device drivers. When prompted to restart, select **No**. Refer to the following sections in this chapter to install the software and drivers contained in the support CD.



NOTE! Because motherboard settings and hardware options vary, use the setup procedures presented in this chapter for general reference only. Refer to your OS documentation for more information.

5.2 Support CD information

The support CD that came with the motherboard contains useful software and several utility drivers that enhance the motherboard features.



NOTE! The contents of the support CD are subject to change at any time without notice. Visit the ASUS website for updates.

5.2.1 Running the support CD

To begin using the support CD, simply insert the CD into your CD-ROM drive. The CD automatically displays the welcome screen and the installation menus if Autorun is enabled in your computer.

5.3 P4S533-VM Motherboard Support CD

NOTE: The support CD contents are subject to change without notice.

To begin using your support CD disc, just insert it into your CD-ROM drive and the support CD installation menu should appear. If the menu does not appear, double-click or run D:\ASSETUP.EXE (assuming that your CD-ROM drive is drive D:).

5.3.1 Installation Menu

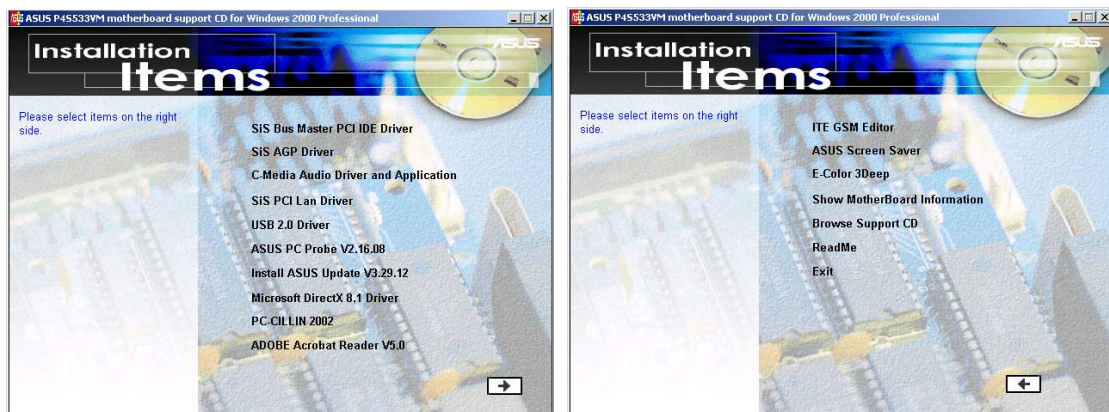

- **SiS Bus Master PCI IDE Driver:** Installs BUS/IDE support driver.
- **SiS AGP Driver:** Installs graphical support driver.
- **C-Media Audio Driver and Application:** Installs the C-Media chipset audio support driver and software.
- **SiS PCI LAN Driver:** Installs the fast ethernet network controller driver.
- **USB 2.0 Driver:** Installs the latest USB 2.0 system driver.
- **ASUS PC Probe Vx.xx:** Installs a smart utility to monitor your computer's fan, temperature, and voltages.
- **Install ASUS Update Vx.xx:** Installs a program that can help you update BIOS or download a BIOS image file.
- **Microsoft DirectX Driver:** Installs basic drivers to enable compatibility with audio and other special functions.
- **PC-Cillin 2002:** Installs the PC-cillin virus protection software. View online help for more information.
- **ADOBE Acrobat Reader:** Installs the Adobe Acrobat Reader software necessary to view user's manuals saved in PDF format. Updated or other language versions of this motherboard's manual is available in PDF format at any of our web sites.

(CLICK THE ARROW ON THE LOWER-RIGHT CORNER)

- **ITE GSM Editor:** Installs the GSM SIM card editing application.
- **ASUS Screen Saver:** Installs a nifty ASUS screen saver.
- **E-Color 3Deep:** Installs graphical driver and an application for tuning the quality of color output from CRT and LCD monitors.
- **Show Motherboard Information:** Allows you to view information about your motherboard, such as product name, BIOS version, and CPU.
- **Browse Support CD:** Allows you to view the contents of the CD.
- **ReadMe:** Allows you to view the support CD file list and contact information.
- **Exit:** Exits the CD installation menu.



It is not advisable to install any software contained on the support CD which does not appear here on the setup menu. The *ITE GSM Editor* will only appear if you have adjusted the *I/O Device Configuration* sub-menu in the *Advanced BIOS*; go to the *UART2* field and select *Smart Card Read*.



The USB 2.0 Driver is supported under the *Win2K* and *WinXP* Operating Systems.

5.4 ASUS PC Probe

ASUS PC Probe is a convenient utility to continuously monitor your computer system's vital components, such as fan rotations, Voltages, and temperatures. It also has a utility that lets you review useful information about your computer, such as hard disk space, memory usage, and CPU type, CPU speed, and internal/external frequencies through the DMI Explorer.

5.4.1 Starting ASUS PC Probe

When ASUS PC Probe starts, a splash screen appears allowing you to select whether or not to show the screen the next time you open PC Probe. To bypass this startup screen, clear the **Show up in next execution** check box.



To start **ASUS PC Probe**, click the Windows **Start** button, point to **Programs**, and then **ASUS Utility**, and then click **Probe Vx.xx**.

The PC Probe icon  will appear on the taskbar's system tray indicating that ASUS PC Probe is running. Clicking the icon will allow you to see the status of your PC.



5.4.2 Using ASUS PC Probe

Monitoring

Monitor Summary

Shows a summary of the items being monitored.

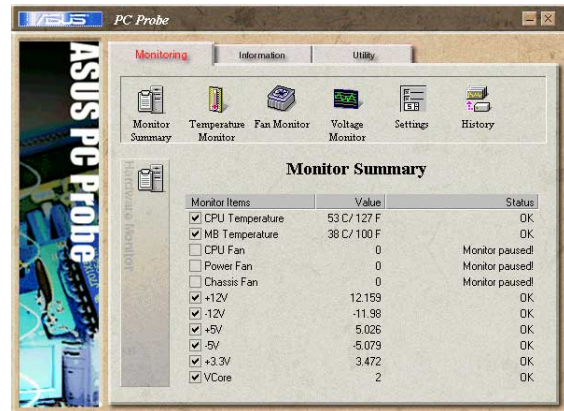

Temperature Monitor

Shows the PC's temperature.

Temperature Warning threshold adjustment
(Move the slider up to increase the threshold level or down to decrease the threshold level)

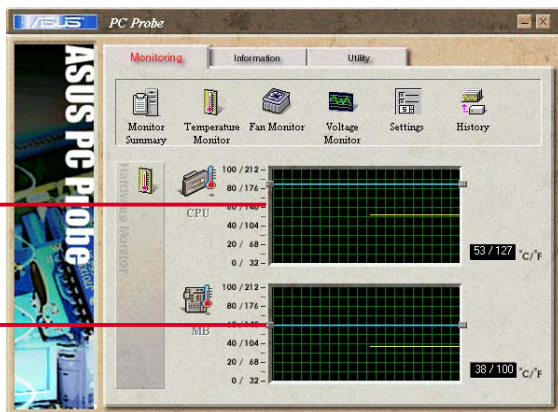

Fan Monitor

Shows the PC's fan rotation.

Fan Warning threshold adjustment
(Move the slider up to increase the threshold level or down to decrease the threshold level)

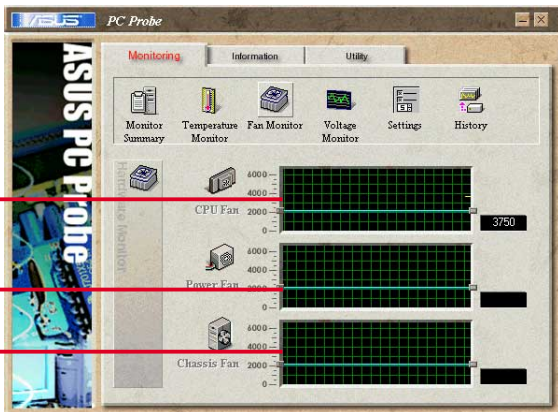

Voltage Monitor

Shows the PC's voltages.

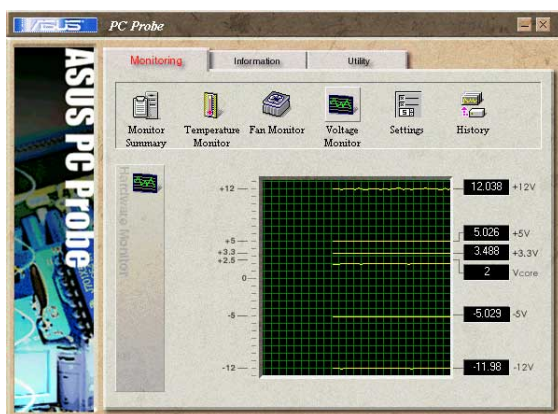

Settings

Lets you set threshold levels and polling intervals or refresh times of the PC's temperature, fan rotation, and voltages.



CPU Cooling System Setup

Lets you select when to enable software CPU cooling. When **When CPU Overheated** is selected, the CPU cooling system is enabled whenever the CPU temperature reaches the threshold value.

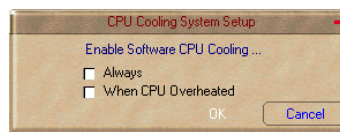

History

Lets you record the current monitoring activity of a certain component of your PC for future reference.

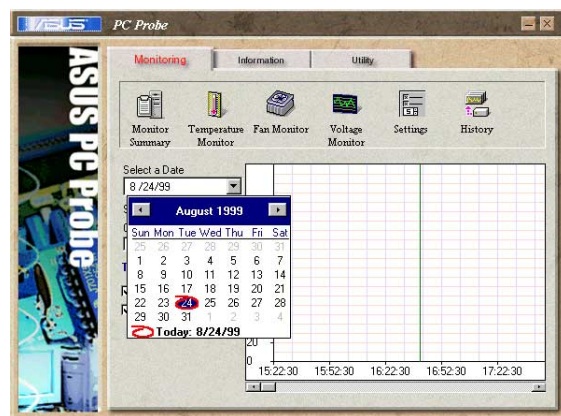

Information

Hard Drives

Shows the used and free space of the PC's hard disk drives and the file allocation table or file system used.

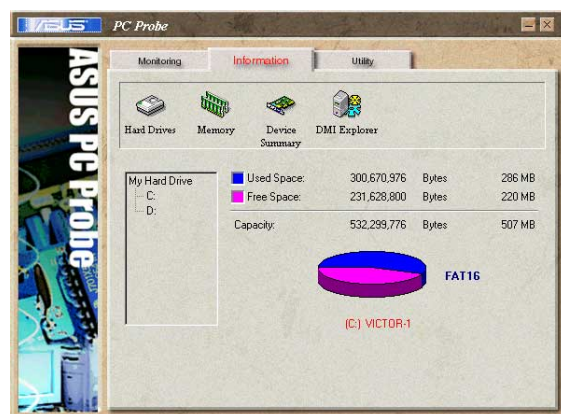

Memory

Shows the PC's memory load, memory usage, and paging file usage.

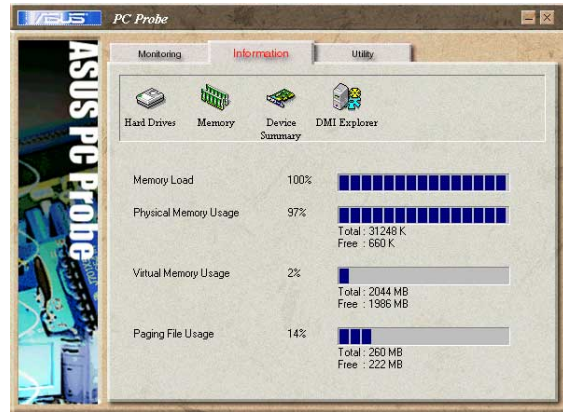

Device Summary

Shows a summary of devices in your PC.



DMI Explorer

Shows information pertinent to the PC, such as CPU type, CPU speed, and internal/external frequencies, and memory size.



Utility

Lets you run programs outside of the ASUS Probe modules. To run a program, click **Execute Program**.



5.4.3 ASUS PC Probe Task Bar Icon

Right-clicking the PC Probe icon will bring up a menu to open or exit ASUS PC Probe and pause or resume all system monitoring.



When the ASUS PC Probe senses a problem with your PC, portions of the ASUS PC Probe icon changes to red, the PC speaker beeps, and the ASUS PC Probe monitor is displayed.

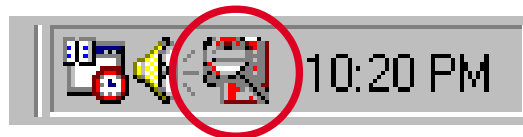

5.5 ASUS Live Update

ASUS LiveUpdate is a utility that allows you to update your motherboard's BIOS and drivers. The use of this utility requires that you are properly connected to the Internet through an Internet Service Provider (ISP).

1. Start ASUS Update. Launch the utility from your Windows Start menu: Programs/AsusUpdate.
2. Select an update method.

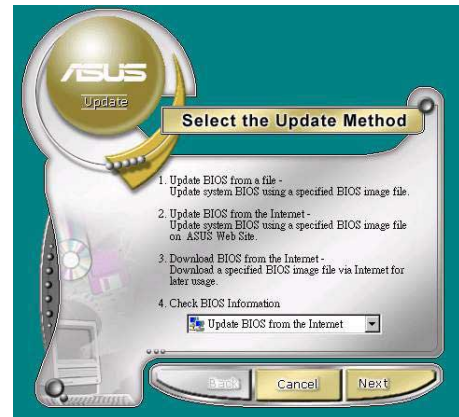

3. If you selected "downloading from the Internet," you will need to select an Internet site. Choose the site that is closest to you or click Auto Select.

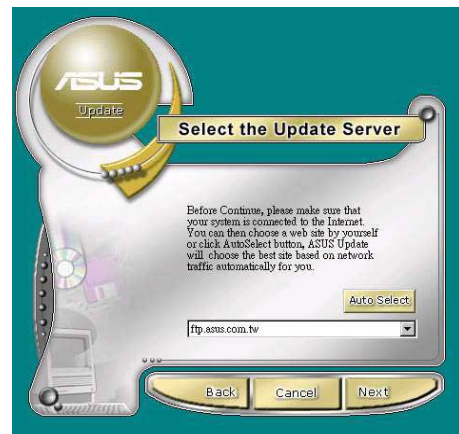

4. From the FTP site, select the BIOS version that you wish to download. Click Next.

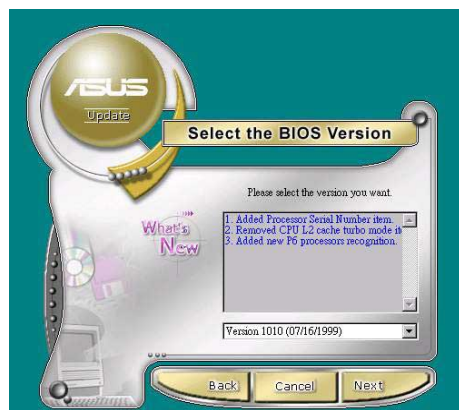

5. Follow the instructions on the succeeding screens to complete the update process. If you selected the option to update the BIOS from a file, a window pops up prompting you to locate the file. Select the file, click Save, then follow the screen instructions to complete the update process.

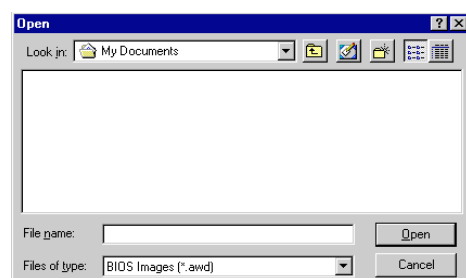

5.6 3Deep Color Tuner

The 3-Deep color tuner is designed to match your CRT or LCD color monitor to maximize the color quality of all graphical applications. Users may also tune their internet applications to match “true” internet source colors with the color displayed on the monitor.

Simply run the setup program from the start menu and follow the instructions on the various setup/test screens.

5.6.1 3Deep Color Tuning

1. Select the type of monitor connected to the computer, either **CRT** or **LCD**.

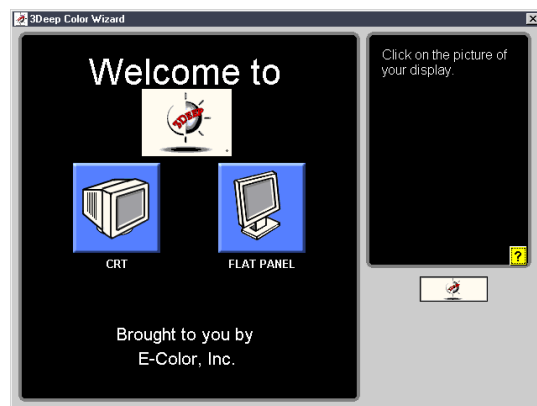

2. Follow the instructions to manually adjust the **brightness** level of the monitor.

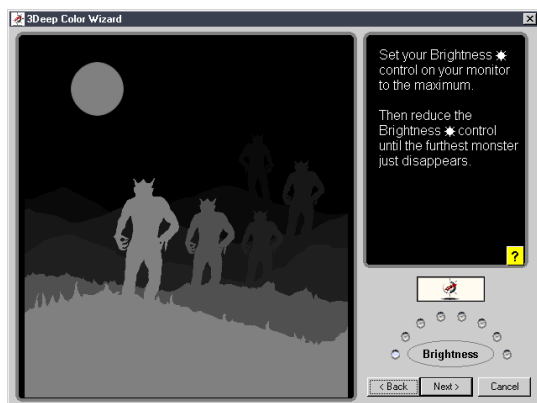

3. Select the faintest of the three colors: **blue**, **red** and **green**.

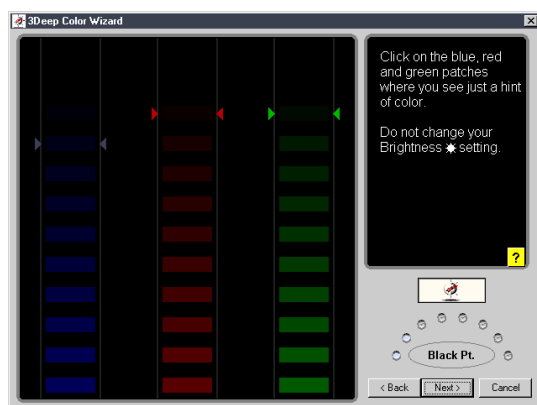

4. Select the color squares which most closely blend and match with the background.

5. The next step repeats the color matching process to achieve full color quality.

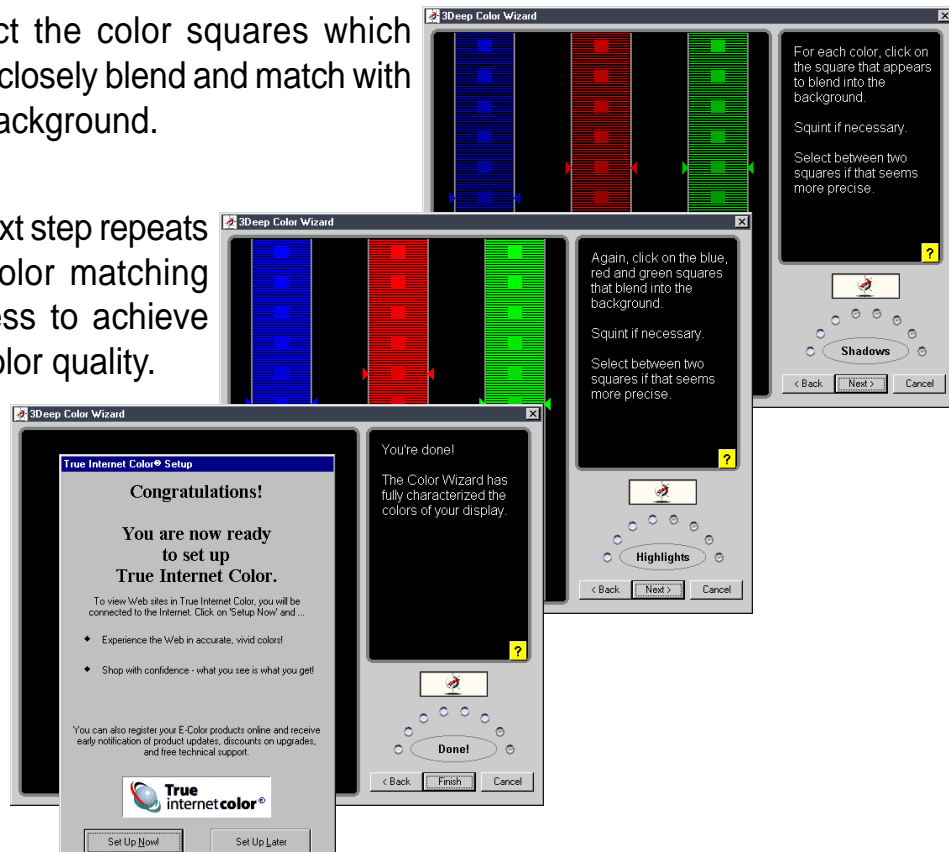

6. The tuning process is complete. Click on the bottom left button to connect to the internet and follow the instructions.

5.6.2 The 3Deep Control Panel

Using the Windows **Start** button, activate the **3Deep Control Panel** program from the **3Deep Applications** group on the **Main Program** menu. The control panel offers access to the **Color Wizard** tuning program, a **Game Gamma** setting and a **Tweak** slider for brightness adjustment.

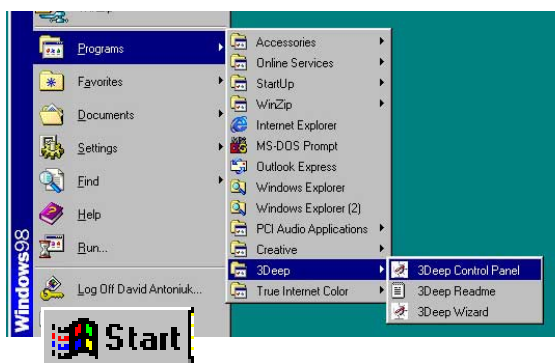

5.7 ITE GSM Editor

The *ITE GSM Editor* is a useful application for editing and managing the data contained on a *GSM cell phone SIM card chip*. This unique software supports access of the SIM card “phone book.” The editor helps you to add or delete data including new names and phone numbers. The software also enables advanced PIN management that includes changing the PIN plus card-lock unblocking.

Setting Up ITE GSM Editor

Connect a *smart card reader* to the P4S533-VM; (refer to *page 38* in *Hardware Setup* for the *connector* location.) Boot-up the PC and enter BIOS (press) to change the configuration to accept smart card hardware: in the *Advanced BIOS* menu select the *I/O Device Configuration* sub-menu, go to *UART2 Function Selection* and choose *Smart Card Read*, save and exit.

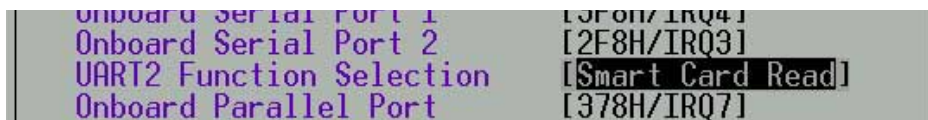

Finish booting up. Insert the ASUS Support CD and click on the selection: *ITE GSM Editor*. The software is auto-installed to the program directory. The new program group appears:

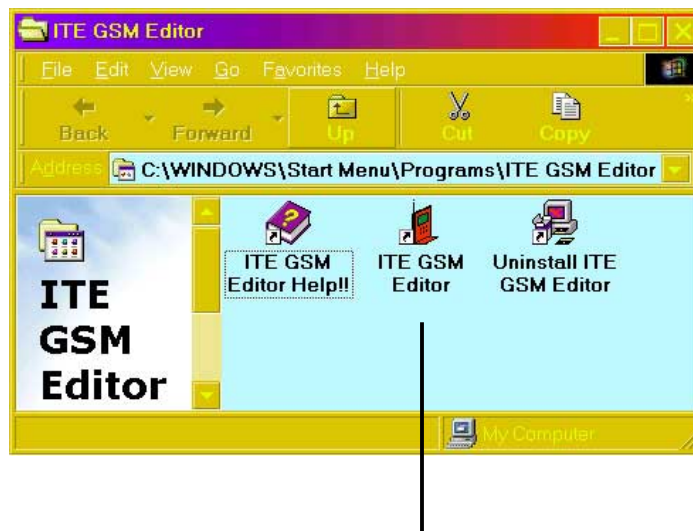

Click on the *ITE GSM Editor* icon to start-up the program.

The ITE GSM menu:



Using the basic ITE GSM Editor:

1. Carefully remove the SIM chip from your mobile phone. The most convenient method to read the SIM chip is to use a conversion card: slip the SIM chip into the conversion card and then insert it into the card reader.
2. To access the phone book contained in the SIM card, either click the chip icon:

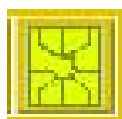

Or, double click the SIM Card:



3. To edit data, select the field and double click it, or press <Enter>. Type in the name and number:



4. The data appears in the field:

No.	Name	Phone No.
1	John Doe	0912345678
2		
3		

5. To save data to the SIM chip, click the save icon:



Using the Command field:



1. **Write All Entries into SIM Card**, and the program writes all new data appearing in the fields onto the SIM card.
2. **Write Revised Entry into SIM Card**, and the program writes all updated entries into the existing SIM card phone book. After revising the data, an icon appears in front of the serial number indicated.
3. **Select Entry to Write into SIM Card**, and the program writes the selected data from the open file into the SIM card database. Users can select multiple entries by pressing <Ctrl> and mouse-selecting the data fields simultaneously.



Phone number entries may be comprised of: "1, 2, 3, 4, 5, 6, 7, 8, 9, #, *, C, or +". Pressing "C" commands the dialer to pause for three seconds before dialing the next digit; the "C" code is useful for dialing extension numbers. Pressing "+" indicates the international head code.

Using the PIN Manager:

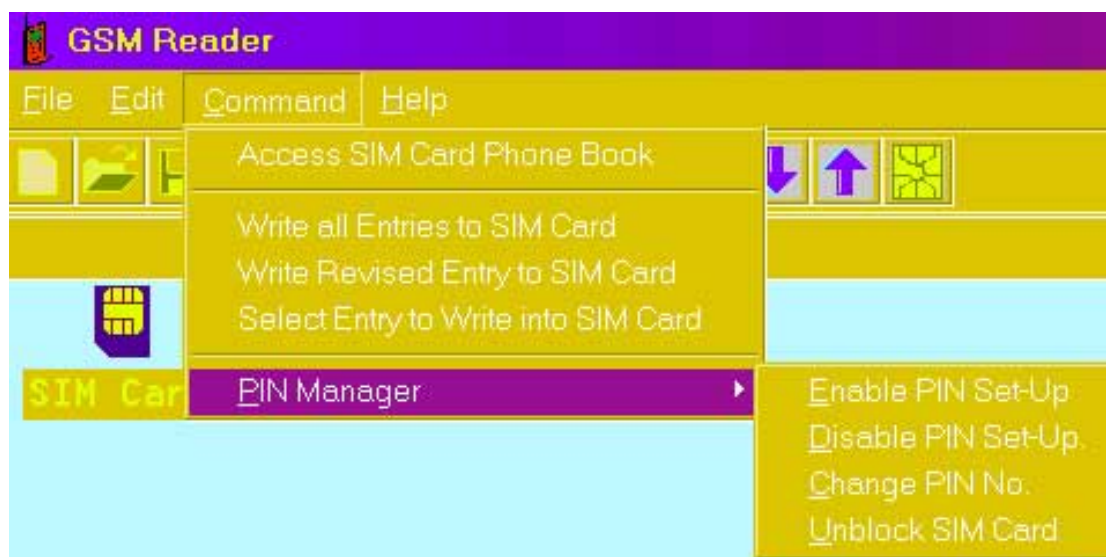

1. **Enable PIN Set-Up:** This function is used to set the PIN. This function is effective only if the *PIN set-up is disabled* and the *SIM card is not blocked*. First enter the PIN set previously to enable the PIN set-up function. New users may find the default PIN in the SIM card user manual. If the correct PIN numbers are entered, the SIM card can be reset. If three consecutive attempts to enter the PIN *fail*, the SIM card is automatically *blocked*.
2. **Disable PIN Set-Up:** This function is used to disable the personal identification number (PIN) set-up. It is effective only when the PIN set-up is enabled and the SIM chip is not blocked. Users should first enter the current PIN to disable the PIN set-up. If the correct PIN numbers are entered, the SIM chip can be reset. If three consecutive attempts to enter the PIN *fail*, the SIM chip is automatically *blocked*.
3. **Unblock SIM Card:** If the SIM chip is locked up, follow the steps below to unlock it:
 - Step 1:* To unblock, enter the PUK (Personal Unblocking Key) consult the SIM chip support documentation for the key code. If the PUK code is not supplied, contact the system operator/dealer.
 - Step 2:* Enter a new PIN.

Glossary

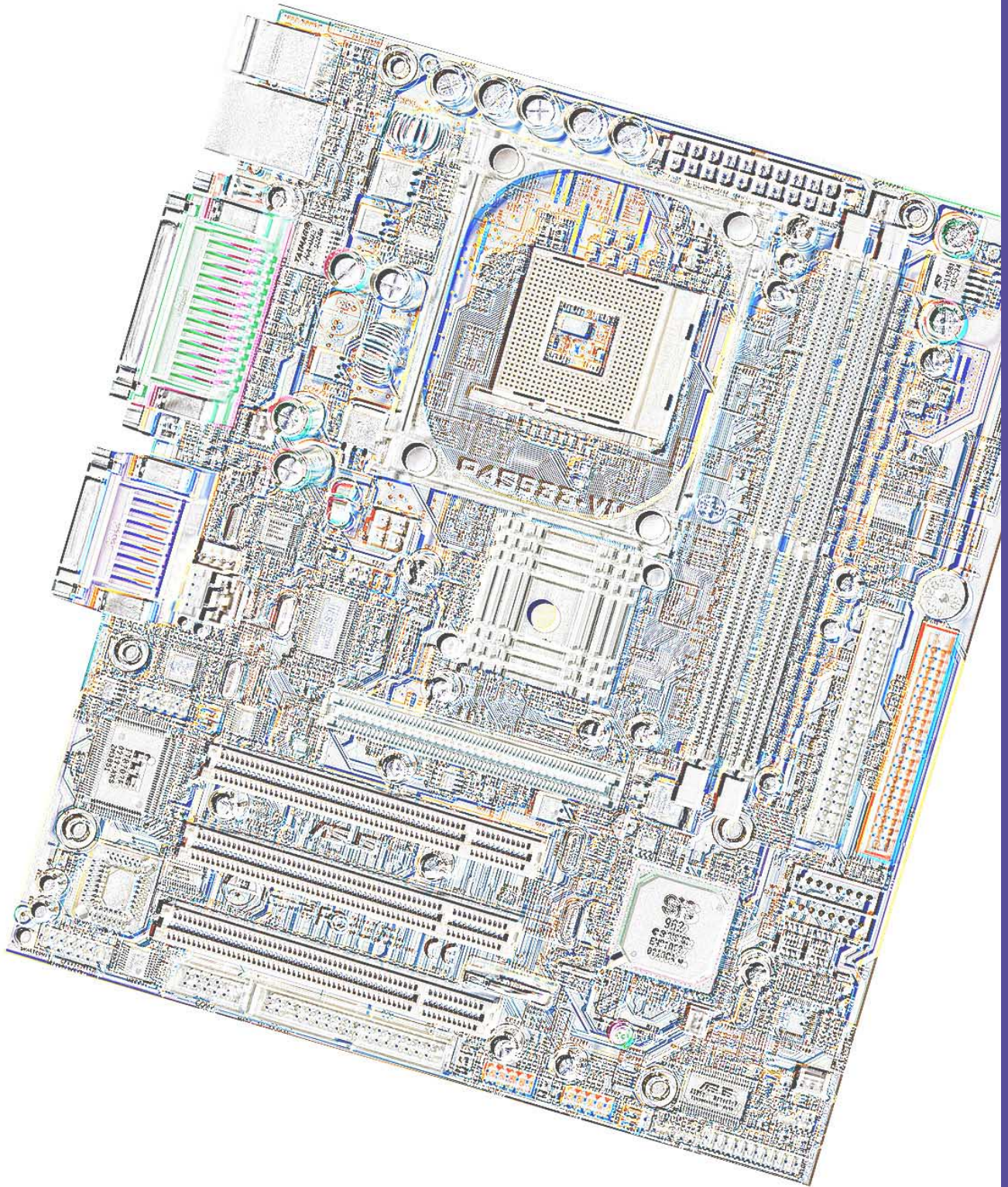

1394

1394 is the IEEE designation for a high performance serial bus that offers data transfers at 100/200/400 Mbps. This serial bus defines both a back plane physical layer and a point-to-point cable-connected virtual bus. The primary application of the cable version is the integration of I/O connectivity at the back panel of personal computers using a low-cost, scalable, high-speed serial interface. The 1394 standard also provides new services such as live connect/disconnect capability for external devices including disk drives, printers and hand-held peripherals such as scanners and cameras. This is a new standard to complement the slower USB interface and to compete with the more expensive SCSI interface.

AC97 (Audio Codec '97)

AC '97 is the next step in enabling PCs with audio quality comparable to consumer electronics devices. The specification defines new cost-effective options to help integrate the components necessary to support next-generation audio-intensive PC applications such as DVD, 3-D multiplayer gaming and interactive music. The specification also defines new extensions supporting modem and docking to help both desktop and mobile manufacturers adopt these new technologies more quickly and cost-effectively. This specification uses software emulation to compete with the PCI SoundBlaster specification.

ACPI (Advanced Configuration and Power Interface)

The ACPI specification defines a cross-platform interface designed to support many operating systems. ACPI defines a flexible and abstract hardware interface that provides a standard way to integrate power management features throughout a PC system, including hardware, operating system and application software. This enables the system to automatically turn ON and OFF peripherals such as CD-ROMs, network cards, hard disk drives, and printers, as well as consumer devices connected to the PC such as VCRs, TVs, phones, and stereos. With this technology, peripherals will also be able to activate the PC. For example, inserting a tape into a VCR can turn on the PC, which could then activate a large-screen TV and high-fidelity sound system.

AGP (Accelerated Graphics Port)

An interface specification that enables high-performance 3D graphics on mainstream PCs. AGP was designed to offer the necessary bandwidth and latency to perform texture mapping directly from system memory.

Bus	Bus Frequency	Bandwidth	Data Transfer Rate
PCI	33MHz	33MHz	133MByte/sec
AGP 1X	66MHz	66MHz	266MByte/sec
AGP 2X	66MHz	133MHz	512MByte/sec
AGP 4X	66MHz	266MHz	1024MByte/sec

Backup. A copy of a file, directory, or volume on a separate storage device from the original. This copy is for the purpose of data retrieval in case the original is accidentally erased, damaged, or destroyed.

BIOS (Basic Input/Output System)

BIOS is a set of routines that affect how the computer transfers data between computer components, such as memory, disks, and the display adapter. The BIOS instructions are built into the computer's read-only memory. BIOS parameters can be configured by the user through the BIOS Setup program. The BIOS can be updated using the provided utility to copy a new BIOS file into the EEPROM.

Bit (Binary Digit)

A bit is the basic unit of digital data used by the computer. A bit equals either: 0 or 1.

Boot

Boot means to start the computer operating system by loading it into system memory. When the manual instructs you to "boot" your system (or computer), it means to turn ON your computer. "Reboot" means to restart your computer. When using Windows 95 or later, selecting "Restart" from "Start | Shut Down..." will reboot your computer.

Bus Master IDE

PIO (Programmable I/O) IDE requires that the CPU be involved in IDE access and waiting for mechanical events. Bus master IDE transfers data to/from the memory without interrupting the CPU. Bus master IDE driver and bus master IDE hard disk drives are required to support bus master IDE mode.

Byte (Binary Term)

One byte is a group of eight contiguous bits. A byte is used to represent a single alphanumeric character, punctuation mark, or other symbol.

Cache Memory. A type of RAM that allows a faster from the CPU than a regular RAM. The cache memory eliminates the CPU wait state. When the CPU reads data from the main memory, a copy of this data is stored in the cache memory. The next time the same address, the data is transferred from the cache memory instead of from the main memory.

CODEC (Compressor/Decompressor). A software component that translates video or audio between its uncompressed form and the compressed form in which it is stored.

COM Port

COM is a logical device name used by to designate the computer serial ports. Pointing devices, modems, and infrared modules can be connected to COM ports. Each COM port is configured to use a different IRQ and address assignment.

Concurrent PCI

Concurrent PCI maximizes system performance with simultaneous CPU, PCI and ISA bus activities. It includes multi-transaction timing, enhanced write performance, a passive release mechanism and support for PCI 2.1 compliant delayed transactions. Concurrent PCI provides increased bandwidth, reduced system latencies, improves video and audio performance, and improves processing of host based applications.

CPU (Central Processing Unit)

The CPU, sometimes called "Processor," actually functions as the "brain" of the computer. It interprets and executes program commands and processes data stored in memory. Currently, there are socket 370 (for Pentium III FC-PGA and Celeron-PPGA), socket 7 (for Pentium, AMD, Cyrix, IBM), slot 1 (for Pentium II and III), slot 2 (for Xeon), and slot A (for AMD) processors.

Device Driver

A device driver is a special set of instructions that allows the computer's operating system to communicate with devices such as VGA, audio, printer, or modem.

DOS (Disk Operating System)

DOS is the foundation on which all other programs and software applications operate, including Windows. DOS is responsible for allocating system resources such as memory, CPU time, disk space, and access to peripheral devices. For this reason, DOS constitutes the basic interface between you and your computer.

DRAM (Dynamic Random Access Memory)

A type of RAM that requires refresh cycles to prevent the loss of the data stored in it. There are several different types of DRAM such as, EDO DRAM (Extended Data Output DRAM), SDRAM (Synchronous DRAM), and RDRAM (Rambus DRAM) and DDR DRAM, (Double-Data Rate DRAM).

Flash ROM

non-volatile memory device that retains its data even when power is removed. This device is similar to EPROM, but unlike EPROM which can be erased only using an ultra-violet light, flash ROM can be electrically erased. Flash ROM is normally used for system BIOS, which initiates hardware devices and sets up necessary parameters for the OS. Since the flash ROM contents can be modified, users can easily update the BIOS..

IDE (Integrated Drive Electronics)

IDE devices integrate the drive control circuitry directly on the drive itself, eliminating the need for a separate adapter card (in the case for SCSI devices). UltraDMA/33 IDE devices can achieve up to 33MB/Sec transfer.

I/O (Input/Output)

The data transfers from the input devices like a keyboard, mouse, or scanner, to the output devices like a printer or the monitor screen.

I/O Address

The specific memory location for a particular device. Two devices cannot share the same I/O address space.

IrDA (Infrared Data Association)

An international organization that creates and promotes inter-operable, low cost, infrared data interconnection standards that support a walk-up, point-to-point model. The IrDA protocol is designed to support transmission of data between two devices over short-range point-to-point infrared at speeds between 9.6Kbps and 4Mbps.

ISP (Internet Service Provider)

A company that provides customer access to the Internet and the World Wide Web for a fee. The ISP also provides Internet utilities and services like e-mail, newsgroup, weather reports, and a host of others. The user can connect to the ISP using a modem installed in the computer and connected to a phone line.

LPT Port (Line Printer Port)

Logical device name reserved by DOS for the computer parallel ports. Each LPT port is configured to use a different IRQ and address assignment.

MMX

A set of 57 new instructions designed to accelerate multimedia and communications applications, such as 3D video, 3D sound, video conference.

Modem

A device that allows a computer to talk to another computer through the phone system.

Network

An interconnected computer system linked by telephone wires, or other means.

OnNow

The OnNow design initiative is a comprehensive, system-wide approach to system and device power control. OnNow is a term for PC that is always ON but appears OFF and responds immediately to user or other requests. The OnNow design initiative involves changes that will occur in the Microsoft Windows operating system, device drivers, hardware, and applications, and also relies on the changes defined in the Advanced Configuration and Power Interface (ACPI) specification.

PC100/133

This is an industry-standard designation for memory capacity as a measure of the speed of the memory bus. New platform requirements ensure that memory does not become a bottleneck to system performance.

PCI Bus (Peripheral Component Interconnect Local Bus)

PCI bus is a standard specification that defines a 32-bit data bus interface.

PCI Bus Master

The PCI Bus Master can perform data transfer without local CPU help and the CPU can be treated as one of the Bus Masters. PCI 2.1 supports concurrent PCI operation to allow the local CPU and bus master to work simultaneously.

POST (Power On Self Test)

Powering on the computer initiates the POST, a series of software-controlled diagnostic tests. The POST checks system memory, the motherboard circuitry, the display, the keyboard, the diskette drive, and other I/O devices.

PS/2 Port

PS/2 ports are based on IBM Micro Channel Architecture. This type of architecture transfers data through a 16-bit or 32-bit bus. A PS/2 mouse and/or keyboard may be used on ATX motherboards.

RDRAM (Rambus DRAM)

Developed by Rambus, Inc., this type of memory can deliver up to 1.6GB of data per second. RDRAM is the first interface standard that can be directly implemented on high performance VLSI components such as, CMOS DRAMs, memory controllers, and graphics/video ICs.

RAM (Random Access Memory). The computer's primary storage area used to write, store, and retrieve information and program instructions which are passed to the CPU for processing. The information in RAM can be repeatedly re-written with new data. Compared to other storage media like magnetic tape, floppy disk, and hard disk, RAM has an extraordinarily fast access rate. RAM, however, is volatile, which means that the data stored in it are lost when the system power is turned off, or if power glitches occur. See also DRAM and SDRAM.

ROM (Read Only Memory)

ROM is nonvolatile memory used to store permanent programs (called firmware) used in certain computer components. Flash ROM (or EEPROM) can be reprogrammed with new programs (or BIOS).

SCSI (Small Computer System Interface)

High speed multi-threaded I/O interface defined by the X3T9.2 committee of the American National Standards Institute (ANSI) for connecting many peripheral devices. The standard started from 10MBytes/sec to 160MBytes/sec available today.

SDRAM (Synchronous DRAM)

A type of DRAM with access signals that are synchronized with the CPU clock, eliminating the delay associated with data transfers between the CPU and memory. SDRAM takes memory access away from the CPU control; internal registers in the memory accept the request, and lets the CPU do something else while the data requested is assembled for the next time the CPU talks to the memory.

SPD for SDRAM module

Serial Presence Detect (SPD) is most like an ID detect for SDRAM module, it using a EEPROM component on DIMM module for storing module configuration information inside. The Serial Presence Detect function is implemented using a 2048 bit EEPROM component. This nonvolatile storage device contains data programmed by the DIMM manufacturer that identifies the module type and various SDRAM organization and timing parameters.

System Disk

A system disk contains the core file of an operating system that boots up the operating system.

TCP/IP (Transmission Control Protocol/Internet Protocol). The communications protocol used by the UNIX system and the Internet. TCP checks for lost packets, puts the data from multiple packets into the correct order, and requests that missing or damaged packets be resent.

USB (Universal Serial Bus)

A 4-pin serial cable bus that allows up to 127 plug and play computer peripherals such as keyboard, mouse, joystick, scanner, printer, modem, and monitor to share a bandwidth through a host scheduled token based protocol. This allows attaching or detaching while the host and other peripherals are in operation. Supports synchronous and asynchronous transfer types over the same set of wires up to 12Mbit/sec. USB 2.0 provides twice the transfer rate compared to USB 1.0 and competes with the 1394 standard.

Wake-On-LAN

Computer will automatically wake-up upon receiving a wake-up packet through a Network interface when it is under power soft-off, suspend or sleep mode.

Index

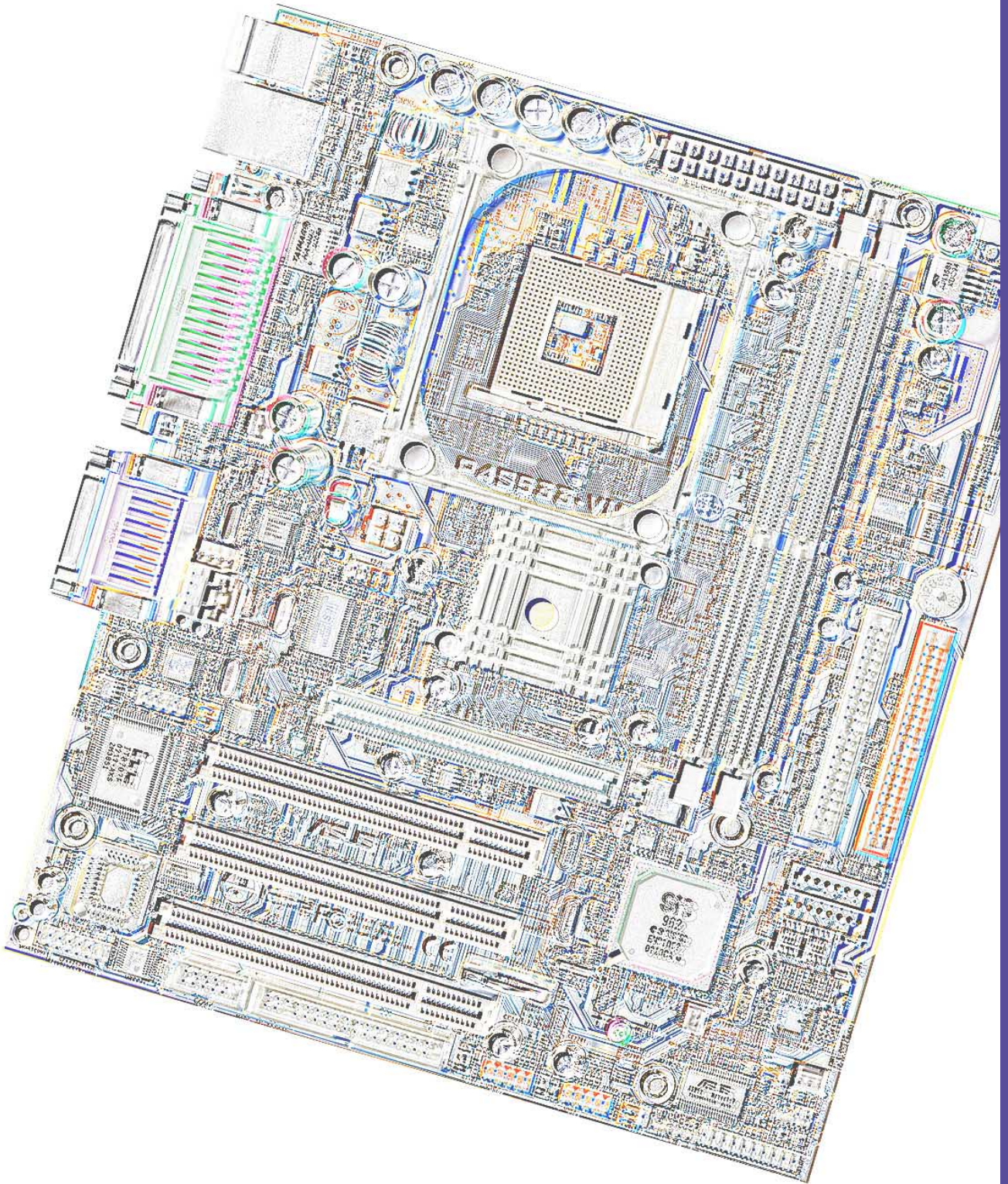

Index

Symbols

3Deep Color Tuner
Using 86

A

Accelerated Graphics Port 23
ASUS PC Probe
Using 80
ASUS Update
Using 85
ATAPI CD-ROM 72
Automatic Power Up 71

B

BIOS
Advanced Menu 57
Beep Codes 41
Boot Menu 72
Boot Sequence 72
Exit Menu 74
Language 56
Legend Bar 48
Main Menu 50
Menu Bar 48
Power Menu 67
Setup Defaults, loading 75
Setup Program 47
Smart BIOS 2
Sub-menu launching 49
Updating 43
BIOS Beep Codes 41
Boot Device
Selection 72
Boot Up NumLock Status 55
Boot Virus Detection 73

C

Central Processing Unit (CPU) 11
External Frequency 25
installation 12
Speed 57
Chip Configuration 59
Clear RTC RAM 28
Connectors
chassis alarm 34
digital audio 37
fan 34
floppy disk 34
Floppy Disk Drive 9
Game/MIDI 9, 31
HDD LED 29
infrared module 37
internal audio 36
Parallel Port 30
power supply 35
primary/secondary IDE 33
PS/2 Keyboard 29
PS/2 Mouse 29
S/PDIF audio 37
Serial Port 30
Smart Card Reader 38
USB 30
USB header 36
CPU external freq. jumper 25

D

DDR SDRAM technology 17
Digital audio interfaces
S/PDIF 3
DIMM
installing 19
removing 20

DIP Switches 24

E

expansion card

installation 21

IRQ assignments 22

Expansion slots 21

F

Floppy 3 Mode 50

Floppy Disk Drive Connector 9

H

Hard Disk Drives (HDDs)

CHS Capacity 53

Cylinders 53

Heads 53

LBA Capacity 53

Primary/Secondary Master 51

Primary/Secondary Slave 51

Sectors 53

Types 51

Hardware Monitor 71

Heatsink

installation 14

I

Interrupt Assignments 22

IRQ assignments 22

ITE GSM Editor 88

J

JumperFree™ Mode 24

Jumpers

Clear RTC RAM 28

CPU external frequency 25

JumperFree mode 24

USB device wake-up 26

K

Keyboard

Auto-Repeat Delay 55

Auto-Repeat Rate 55

Connector 29

Features 55

L

Legacy Diskette 50

LiveUpdate 86

Using 86

M

Motherboard

IRQ Table 22

layout 8, 9

placement 7

screws 7

Mouse

Connector 29

Multi-Sector Transfers 53

O

Operating system

installation 77

P

Parallel Port 62

Modes 62

Parallel Port Connector 30

Password

Supervisor 56

User 56

PC Probe

Using 80

PCI Configuration 64

PCI Latency Timer 64

PCI/VGA Palette Snoop 64

- PIO Mode 54
- Plug & Play O/S 73
- Power Management 67
- Power On Self Test 73
- PS/2 Keyboard 29
- PS/2 Keyboard Port 2
- PS/2 Mouse 29
 - Function Control 58
- PS/2 Mouse Port 2

S

SDRAM

- Active to Precharge Time 59
- CAS Latency 59
- Configuration 59
- RAS to CAS Delay 59

Serial Ports 62

- Connectors 30

slots

- AGP 23
- PCI 23

Smart Card Reader 38

Smart Manager 88

SMART Monitoring 54

Sony/Philips Digital Interface (S/PDIF) 3

Support CD 77

- Welcome screen 77

Suspend Mode 68

System Date 50

System memory

- configurations 17

System Time 50

U

- UART2 64
- Ultra DMA Mode 54
- Universal Serial Bus (USB) 30
 - Ports 30
- USB Legacy Support 59

Using

- 3Deep Color Tuner 86
- ASUS Update 85
- ITE GSM Editor 88
- LiveUpdate 86
- PC Probe 80

USWC 60

Z

- ZIF socket 11

